



**ISO 9001 Certified Fitting
and Valve Manufacturer**



for DIN 2353 / ISO 8434-1

DK DIN Bite Type Tube Fitting

Catalog No.03-2
October, 2010

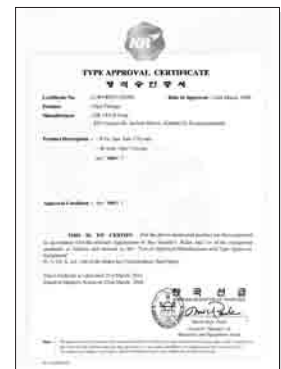

Design

The DK DIN bite type tube fitting is a flareless metric fitting that consists of a body, a progressive ring (sleeve) and a nut. On assembly, two cutting edges of the progressive ring bite into the outer surface of the tube ensuring the holding for high Tube pressure.



Available in three series, DK DIN bite type tube fittings and accessories are manufactured in accordance with DIN2353/DIN EN ISO8434-1. The fittings and components in this catalog are intended solely for the assembly of connections for fluid applications.

Function of DK DIN bite type tube fitting

DK DIN bite type tube fitting produces a low to high pressure, leak free connection of tubes and components in fluid systems. The basic function of the DK DIN bite type tube fitting is the controlled progressive bite of the ring (sleeve) into the tube due to a unique internal geometry.

The front cutting edge (A) has already started cutting into the tube before the second cutting edge (B) starts. As soon as both cutting edges have cut the tube to the designed depth further advance is limited by the stop edge (C).

Owing to the design of both cutting edges and stop edge all forces arising are equally distributed. This distribution along with the specially designed interior collar (D) of the ring guarantees increased safety, particularly with regard to vibration and flexure stresses. The design and function of the cutting ring ensure that service vibration loading is not present in the areas of the tubing where the bite is made.

The stop edge causes a sharp increase in tightening forces which is clearly perceptible. After assembly, a visible collar (E) of cut tube material must completely fill the space in front of the first cutting edge. With stainless steel tube and hose connections made from free cutting steel, the collar is less due to the harder material.

During assembly, it is absolutely essential that the tube is held firmly against the stop in the inner cone of the fitting; if not, the cutting process will not take place satisfactorily. Reassembly can be performed an unlimited number of times.

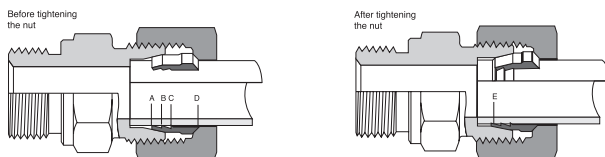

Material specification

Fitting Materials	Steel	DIN 3859
	Brass	CUZn35Ni2 in accordance with DIN17660/17672, Material No. 2.0540
	Stainless Steel	X6CrNiMoTi 17122 to DIN17440 Material No. 1.4571 or ASTM A479 type 316
Elastomer Materials	Buna-N	
	Viton	DIN 17660 FPM(VITON)

Pressure and temperature load Capability

Pressure Load Capability

Definition of pressures specified in the catalog:

a) Nominal pressure PN

The nominal pressure as referred to in DIN 2401, part 1 draft.

b) Working pressure PB

The permissible working pressure for a component is based on the material and the operation temperature (TB) during trouble-free operation (DIN 2401, part 1 draft).

Pressure Ranges

Series	Steel / Brass*		1.4574(SS316)	
	Size	Pressure	Size	Pressure
LL	4-12	100 bar	4-8	100 bar
L	6-18	315 bar	6-15	250 bar
	22-42	160 bar	18-22	160 bar
S	6-14	630 bar	6-14	630 bar
	16-30	400 bar	16-25	400 bar
	38	315 bar	30-38	315 bar

Brass*: Pressure range of brass should be adapter 30% below of the steel.

Pressure reductions

Recommended pressure reductions (determined by the fluid medium) for higher service temperatures.

Materials Of fittings	Temperature range		Pressure Reductions
	°C	°F	
Steel	-40°to + 120°C	-40°F to 250°F	-
Brass	-60° to + 175°C	-75°F to 350°F	30%
1.4571	-60° to + 20°C	-75°F to 70°F	-
1.4571	+ 50°C	+120°F	4%
1.4571	+ 100°C	+212°F	11%
1.4571	+ 200°C	+400°F	20%
1.4571	+ 300°C	+570°F	29%
1.4571	+ 400°C	+750°F	33%

If the tube material used deviates from the fitting material, the tube is to be checked separately with regard to the permissible temperature range and the possible pressure reductions required. Male stud fittings may require additional pressure reductions, due to the mating port material, and the sealing mechanism must also be taken into account. For male stud fittings with cutting face, additional sealants may be required.

Fluids

DK-LOK Corp. DIN fittings are designed for the use of commercial hydraulic oils. If special fluids please contact our application engineers.

Permissible operating temperature(TB) range

A) For fittings materials

Material	Temperature
Steel	-40°C up to + 120°C (DIN 3859)
Brass	-60°C up to + 175°C (DIN 17660/17672)
Stainless steel	-60°C up to + 400°C (DIN 17440)

Please refer to the information given in the section "Reduction of Pressure"

B) For sealing materials

Material	Temperature
NBR (e.g. Perbunan)	-35°C up to + 100°C
FPM (e.g. Viton)	-25°C up to + 200°C
PTFE (e.g. Teflon)	-60°C up to + 240°C

DK DIN Bite Type Tube Fitting

Tubing guide

• Seamless precision steel tube St 37.4

We recommend the use of seamless precision steel tubes with dimensions to DIN 2391, part 1, material St 37.4 to DIN 1630, type NBK. The following tube wall thickness are suitable for use;

Tube O.D (D)	Tolerance	Wall Thickness (t)	Design Pressure		Weight
			DIN 2413		
			I Static	III Dynamic	
mm	mm	mm	bar	bar	Kg/m
4	± 0.1	0.5	313	274	0.047
		0.75	409	391	0.060
		1	522	500	0.074
6	± 0.1	0.75	333	289	0.103
		1	389	372	0.123
		1.5	549	526	0.166
		2	692	662	0.197
8	± 0.1	2.25	757	725	0.208
		1	333	288	0.173
		1.5	431	412	0.240
10	± 0.1	2	549	526	0.296
		2.5	658	630	0.339
		1	282	248	0.222
12	± 0.08	1.5	373	357	0.314
		2	479	458	0.395
		2.5	576	551	0.462
		3	666	638	0.518
		1	235	209	0.271
15	± 0.08	1.5	353	303	0.389
		2	409	391	0.493
		2.5	495	474	0.586
		3	576	551	0.606
16	± 0.08	3.5	651	624	0.734
		1	188	171	0.345
		1.5	282	248	0.499
		2	336	321	0.641
18	± 0.08	2.5	409	391	0.771
		3	478	458	0.888
		1	176	160	0.370
		1.5	264	234	0.536
20	± 0.08	2	353	303	0.691
		2.5	386	370	0.832
		3	452	433	0.962
		1	157	143	0.419
22	± 0.08	1.5	235	209	0.271
		2	313	273	0.789
		2.5	348	333	0.956
		3	409	391	1.110

Tube O.D (D)	Tolerance	Wall Thickness (t)	Design Pressure		Weight
			DIN 2413		
			I Static	III Dynamic	
mm	mm	mm	bar	bar	Kg/m
20	± 0.08	1.5	212	191	0.684
		2	282	249	0.888
		2.5	353	303	1.08
		3	373	357	1.26
		3.5	426	408	1.424
22	± 0.08	4	478	458	1.578
		1	128	118	0.518
		1.5	192	174	0.758
		2	256	227	0.986
25	± 0.08	2.5	320	278	1.202
		3	343	328	1.406
		2	226	201	1.134
		2.5	282	248	1.387
28	± 0.08	3	338	292	1.628
		4	394	378	2.072
		4.5	437	418	2.275
		5	478	458	2.446
30	± 0.08	1.5	151	139	0.980
		2	201	181	1.282
		2.5	252	223	1.572
		3	302	264	1.850
		4	357	342	2.368
35	± 0.15	5	434	415	2.836
		2	188	171	1.381
		2.5	235	210	1.695
		3	282	248	2.00
38	± 0.15	4	336	321	2.57
		5	409	391	3.08
		2	161	147	1.63
		2.5	201	181	2.00
42	± 0.2	3	242	215	2.37
		4	322	280	3.06
		5	357	342	3.69
		6	409	401	4.29
48	± 0.15	2.5	186	168	2.189
		3	223	200	2.589
		4	297	260	3.35
		5	332	318	4.07
54	± 0.15	6	390	373	4.74
		7	446	427	5.35
		2	134	124	1.973
60	± 0.2	3	201	181	2.89
		4	269	237	3.75

• **Seamless precision stainless steel 1.4571**

Stainless steel tubes (e.g. 1.4571), code X6CrNiMoTi 17122, must be cold-drawn and seamless, heat-treated without formation of scales, type me to Din 17458, provide tolerances to DIN 2391, Part 1.

The following tube wall thickness are suitable for use ;

Tube O.D (D)	Tolerance	Wall Thickness (t)	Design Pressure		Weight
			DIN 2413		
			I Static	III Dynamic	
mm	mm	mm	bar	bar	Kg/m
4	±0.1	0.75	391	376	0.061
4		1	500	480	0.075
6	±0.1	1	372	357	0.125
6		1.5	526	505	0.168
6		2	662	637	0.200
6		2.25	725	696	0.211
8	±0.1	1	347	277	0.175
8		1.5	412	396	0.244
8		2	526	505	0.300
8		2.5	630	604	0.344
10	±0.08	1	294	238	0.225
10		1.5	357	343	0.319
10		2	458	439	0.401
10		2.5	551	529	0.469
10		3	638	612	0.525
12	±0.08	1	245	201	0.275
12		1.5	368	291	0.394
12		2	391	376	0.501
12		2.5	474	455	0.594
12		3	551	529	0.615
12		3.5	624	599	0.744
15	±0.08	1.5	294	238	0.507
15		2	321	309	0.651
15		2.5	391	376	0.782
15		3	458	439	0.901
16	±0.08	2	368	291	0.701
16		2.5	370	355	0.845
16		3	433	416	0.977
18	±0.08	1.5	245	201	0.620
18		2	327	262	0.801
18		2.5	333	320	0.967
18		3	391	376	1.126

Tube O.D (D)	Tolerance	Wall Thickness (t)	Design Pressure		Weight
			DIN 2413		
			I Static	III Dynamic	
mm	mm	mm	bar	bar	Kg/m
20	±0.08	2.5	368	291	1.095
20		3	357	343	1.277
20		3.5	408	392	1.433
20		4	458	439	1.600
22	±0.08	2	267	218	1.002
22		2.5	334	267	1.220
22		3	328	315	1.426
25	±0.08	2	235	193	1.152
25		2.5	294	238	1.408
25		3	353	281	1.635
25		4	378	363	2.092
25		4.5	418	402	2.307
25		5	458	439	2.501
28	±0.08	2	210	174	1.302
28		2.5	263	214	1.594
28		3	315	253	1.874
28		4	342	328	2.402
28		5	415	399	2.876
30	±0.08	3	294	238	2.028
30		4	321	309	2.605
30		5	391	376	3.400
35	±0.15	2	168	141	1.644
35		2.5	210	174	2.018
35		3	252	206	2.392
35	±0.15	4	336	269	3.086
35		5	342	328	3.742
35		6	401	385	4.351
38	±0.15	4	309	249	3.405
38		5	318	305	4.131
38		6	373	358	4.807
38		7	427	410	5.426
42	±0.2	3	210	174	2.930
42		4	280	227	3.798

DK DIN Bite Type Tube Fitting

Stud Ends & Tapped Hole Forms for tube Fittings.

This standard specifies dimensions for stud ends and tapped holes with metric fine pitch thread and pipe thread for use with Compression fittings, valves and screw plugs, general outlay of types.

Forms of stud Ends

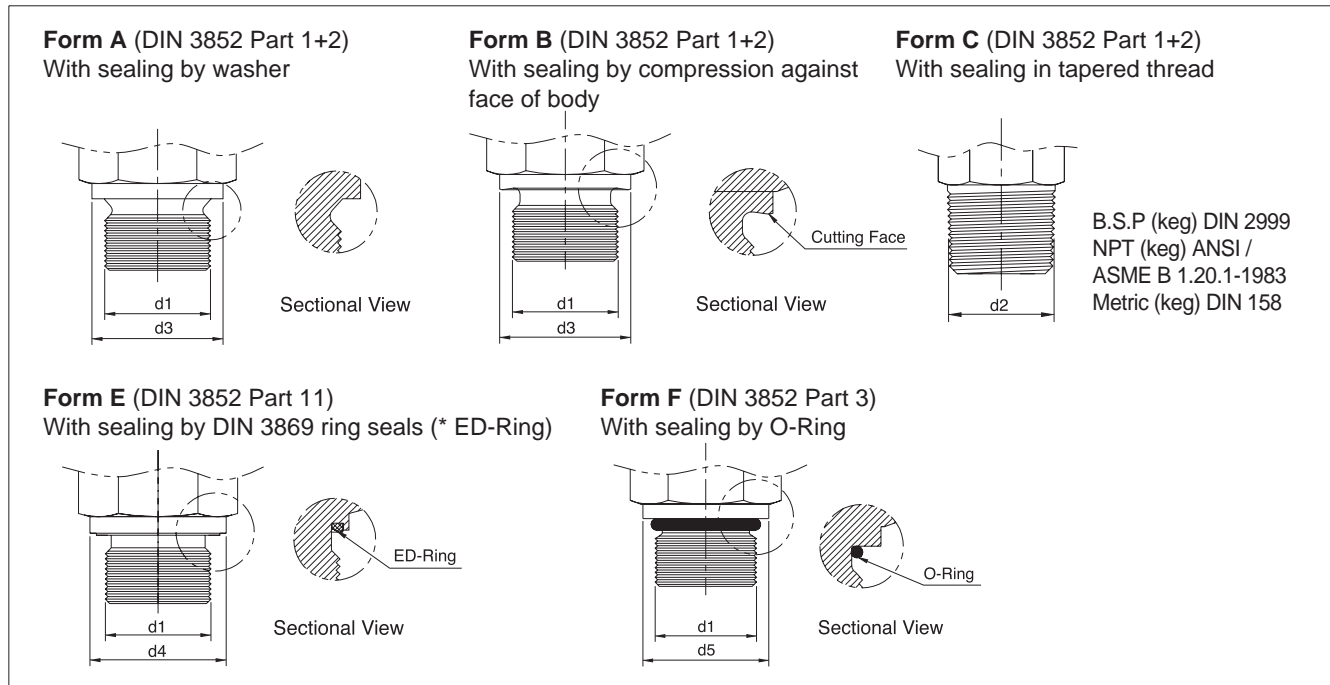

Thread size for		d_3	$d_4 - 0.2$	$d_5 \pm 0.1$
Form A,B and E,F d_1	Form C stud ends d_2			
M8 X 1.0	M8 X 1.0 keg.	-	-	10.9
M10 X 1.0	M1.0 X 1.0 keg.	14	13.9	12.9
M12 X 1.5	M12 X 1.5 keg.	17	16.9	16.9
M14 X 1.5	M14 X 1.5 keg.	19	18.9	18.9
M16 X 1.5	M16 X 1.5 keg.	21	21.9	20.9
M18 X 1.5	M18 X 1.5 keg.	23	23.9	22.9
M20 X 1.5	M20 X 1.5 keg.	25	25.9	24.9
M22 X 1.5	M12 X 1.5 keg.	27	26.9	26.9
M26 X 1.5	-	31	31.9	30.9
M 27 X 2.0	-	32	31.9	31.9
M 33 X 2.0	-	39	39.9	37.9
M 42 X 2.0	-	49	49.9	47.9
M 48 X 2.0	-	55	54.9	54.9

Thread size for		d_3	$d_4 - 0.2$	$d_5 \pm 0.1$
Form A,B and E,F d_1	Form C stud ends d_2			
G 1/8	1/8 NPT	14	13.9	-
G 1/4	1/4 NPT	18	18.9	-
G 3/8	3/8 NPT	22	21.9	-
G 1/2	1/2 NPT	26	26.9	-
G 3/4	3/4 NPT	32	31.9	-
G 1	1 NPT	39	39.9	-
G 1 1/4	1 1/4 NPT	49	49.9	-
G 1 1/2	1 1/2 NPT	55	54.9	-
7/16 - 20UNF	R 1/8 keg.	-	-	14.4
9/16 - 18UNF	R 1/4 keg.	-	-	17.6
3/4 - 16UNF	R 3/8 keg.	-	-	22.3
7/8 - 14UNF	R 1/2 keg.	-	-	25.5
1 1/16 - 12UN	R 3/4 keg.	-	-	31.9
1 5/16 - 12UN	R 1 keg.	-	-	38.2

Note: DK Standards Sealing Material is NBR (-20°C to +100°C)
Other Sealing Materials are available on Request.

Forms of tapped holes

Form X (DIN 3852 Part 1+2)

For parallel Stud Ends. (From A,B)

* d7 is for Stud Ends From E

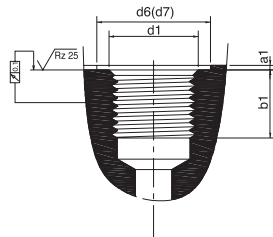

Form W (DIN 3852 Part 3)

For Stud Ends with O-Ring. (From F)

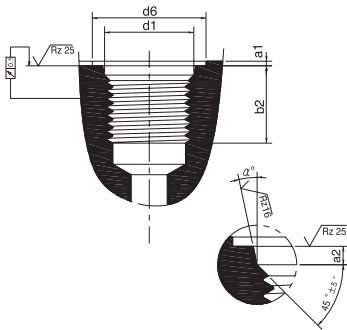

Form Z (DIN 3852 Part 1+2)

For tapered thread Stud Ends.

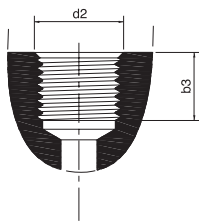

Thread size for		d ₆ min	d ₇	a ₁ max	a ₂ +0.4	b ₁ min	b ₂ min	b ₃ min	α° ± 1°
Form X.W Tapped Holes d ₁	Form Z Tapped Holes d ₂								
M 8 X 1.0	M8 X 1.0 keg.	13	-	1	1.6	-	10	5.5	12
M 10 X 1.0	M1.0 X 1.0 keg.	15	15	1	1.6	8	10	5.5	12
M 12 X 1.5	M12 X 1.5 keg.	18	18	1.5	2.4	12	11.5	8.5	12
M 14 X 1.5	M14 X 1.5 keg.	20	20	1.5	2.4	12	11.5	8.5	15
M 16 X 1.5	M16 X 1.5 keg.	22	23	1.5	2.4	12	13	8.5	15
M 18 X 1.5	M18 X 1.5 keg.	24	25	2	2.4	12	14.5	8.5	15
M 20 X 1.5	M20 X 1.5 keg.	26	27	2	2.4	14	14	10.5	15
M 22 X 1.5	M12 X 1.5 keg.	28	28	2.5	2.4	14	15.5	10.5	15
M 26 X 1.5	-	32	33	2.5	3.1	16	16	-	15
M 27 X 2.0	-	33	33	2.5	3.1	16	19	-	15
M 33 X 2.0	-	40	41	2.5	3.1	18	19	-	15
M 42 X 2.0	-	50	51	2.5	3.1	20	19.5	-	15
M 48 X 2.0	-	56	56	2.5	3.1	22	22	-	15
G 1/8	1/8 NPT	15	15	1	-	8	-	6.9	-
G 1/4	1/4 NPT	19	20	1.5	-	12	-	10	-
G 3/8	3/8 NPT	23	23	2	-	12	-	10.3	-
G 1/2	1/2 NPT	27	28	2.5	-	14	-	13.6	-
G 3/4	3/4 NPT	33	33	2.5	-	16	-	14.1	-
G 1	1 NPT	40	41	2.5	-	18	-	16.8	-
G 1 1/4	1 1/4 NPT	50	51	2.5	-	20	-	17.3	-
G 1 1/2	1 1/2 NPT	56	56	2.5	-	22	-	17.3	-
7/16 - 20UNF	R 1/8 keg.	21	-	1.6	2.4	-	11.5	5.5	12
9/16 - 18UNF	R 1/4 keg.	25	-	1.6	2.5	-	12.7	8.5	12
3/4 - 16UNF	R 3/8 keg.	30	-	2.4	2.5	-	14.3	8.5	15
7/8 - 14UNF	R 1/2 keg.	34	-	2.4	2.5	-	16.7	10.5	15
1 1/16 - 12UN	R 3/4 keg.	41	-	2.4	3.3	-	19	13	15
1 5/16 - 12UN	R 1 keg.	49	-	3.2	3.3	-	19	16	15
1 5/8 - 12UN	R 1 1/4 keg.	58	-	3.2	3.3	-	19	17	15
-	R 1 1/2 keg.	-	-	-	-	-	-	17	-

DK DIN Bite Type Tube Fitting

This assembly instruction applicable to DIN 2353 fittings shows suitable make-up of fittings into seamless pipe in accordance with DIN 3859.

3 Methods might be employed for assembling -

- Assemble the fitting body directly.
- Using pre-swaging tool for assembly.
- Assemble standpipe & cone fitting with O-ring

In order to ensure positive assembly, stainless steel fittings should be always pre-assembly In and oiled pre-assembly tool. (see page 8)

◆ Assemble the fitting body directly.

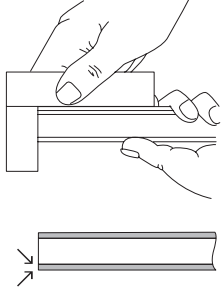
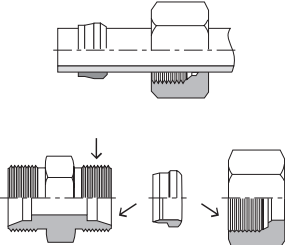
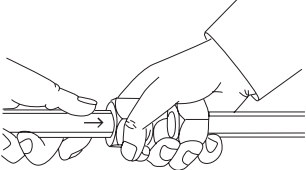
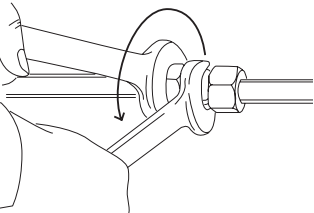
	<p>1.0 Saw the tube at right angle. An angular offset of $1/2^\circ$ in relation to the tube axis is permissible.</p> <p>1.1 After clean, lightly deburr tube ends at the inside and outside edge.</p> <p style="text-align: center;">0.2</p> <p>1.2 Don't use a tube cutter because this would cause formation of considerable burrs and an angular cut. Use sawing machine or device instead.</p>
	<p>2.0 Lubricate thread and inside of fitting body also cutting ring and thread of nut. Don't use grease.</p> <p>2.1 Place nut and cutting ring on tube shown. Ensure cutting ring and nut are facing the right way.</p>
	<p>3.0 Press tube into fitting body, up to tube abutment, then hand-tighten the nut.</p>
	<p>4.0 Make sure the nut is in hand tight position, then the 1 1/2 turns with wrench by holding fitting body with a second wrench. (Never turn fitting body, hold body and turn nut)</p> <p>Caution! Any deviating number of tightening turns reduces the nominal pressure and the service life of the fitting and may cause leakages or slipping of the tube.</p>

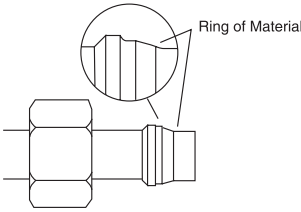
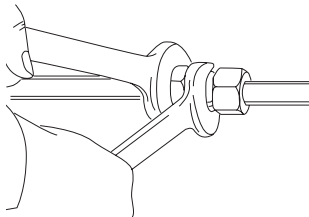
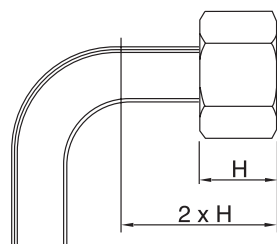
	<p>5.0 Check penetration of cutting edge. A visible ring of material should fill the space in front of the cutting ring and face. Cutting ring may turn on tube, but should not be capable of axial displacement.</p>
	<p>6.0 Each time the fitting is disassembled, the nut must be retightened firmly using the same torque as required for final assembly.</p>
	<p>7.0 Minimum length of straight tube and for tube bends, up to start of the bending radius must be at least twice (2 X H) the nut length (H)</p>

◆ Using pre-swaging tool for assembly.

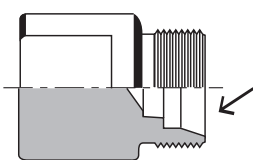
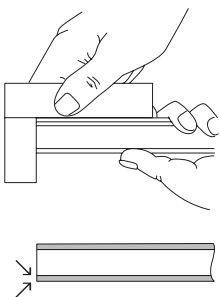
	<p>1.0 In order to ensure positive assembly DK-Lok Corporation DIN fittings should always be pre-assembled in on oiled pre-assembly tool. For direct assembly, torque-controlled assembly or mechanical pre-assembly, which are also possible. Please refer to separate assembly instructions.</p>
	<p>2.0 Saw the tube at right angle. An angular offset of 1/2° in relation to the tube axis is permissible. 2.1 After clean, lightly deburr tube end at the inside and outside edge. 2.2 Don't use a tube cutter because this would cause formation of considerable burrs and an angular cut. Use sawing machine or device instead.</p>

DK DIN Bite Type Tube Fitting

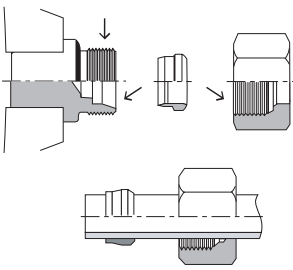
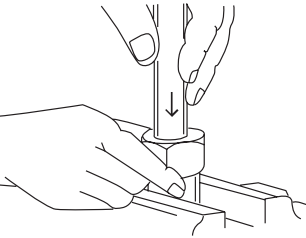
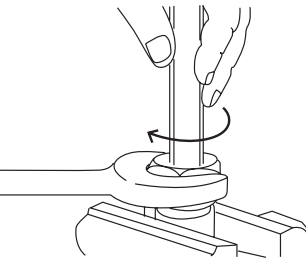
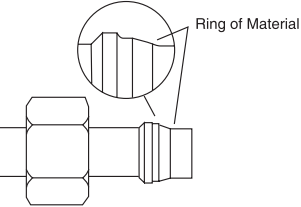
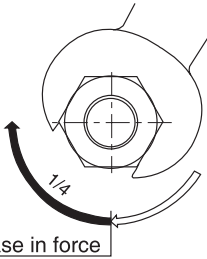
	<p>3.0 Lubricate thread and inside of fittings body also cutting ring and thread of nut. Don't use grease.</p> <p>3.1 Please nut and cutting ring on tube shown. Ensure cutting ring and nut are facing the right away.</p>
	<p>4.0 Press tube into fitting body, up to tube abutment, then hand-tighten the nut.</p>
	<p>5.0 Make sure the nut is in hand tight position, then the 1 1/4 turns with wrench by holding fitting body with a second wrench(Never turn fitting body, hold body and turn nut)</p> <p>Caution! Application of deviating numbers of tightening turns reduces the nominal pressure rating and the life of the fitting which cause leakage or slipping of the tube.</p>
	<p>6.0 Check penetration of cutting edge. A visible ring of material should fill the space in front of the cutting ring and face. Cutting ring may turn on tube but should not be capable of axial displacement.</p>
	<p>7.0 Tighten nut until a noticeable increase in force is required. Beyond this point, tighten the nut by 1/4 turn with wrench for final assembly. Hold fitting body by means of a wrench.</p> <p>7.1 With unfavorable mounting conditions and great tube dimensions, final assembly must be completed in via with the fitting body.</p> <p>Caution! Any deviating number of tightening turns reduces the nominal pressure and the service life of the fitting and may cause leakages or slipping of the fitting.</p>

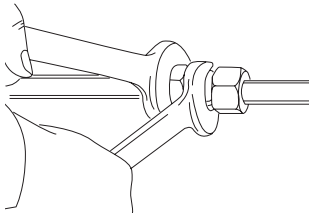
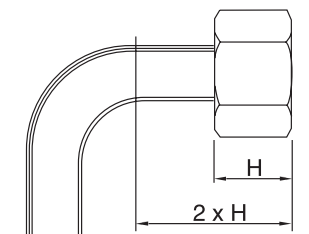
	<p>8.0 Each time the fitting is disassembled, the nut must be retightened firmly using the same torque as required for final assembly.</p>
	<p>9.0 Minimum length of straight tube and for tube bends, up to start of the bending radius must be at least twice(2XH) the nut length(H)</p>

◆ Assemble standpipe & cone fitting with O-ring.

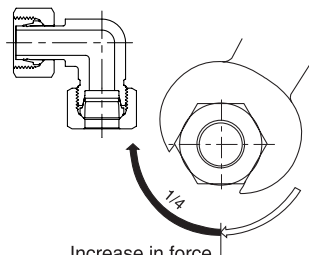
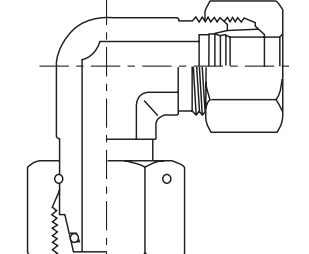
	<p>1.0 Standpipes are generally supplied with pre-assembled cutting ring Tighten the nut 1/4 turn with wrench beyond the point of a noticeable increase in force. Hold fitting body firmly by means of wrench</p> <p>1.1 With unfavorable mounting conditions and great tube dimensions, final assembly must be completed in a vice with the fitting body to be subsequently installed.</p> <p>Caution! Any deviating number of tightening turns reduces the nominal pressure and the service life of the fitting and may cause leakages or slipping of the fitting.</p>
	<p>2.0 Oil O-ring Tighten nut 1/4 of a turn beyond the point of a noticeable increase in force. Hold fitting body firmly by means of wrench.</p> <p>2.1 With unfavorable mounting conditions and great tube dimensions, final assembly must be completed in a vice with the fitting body to be subsequently installed.</p> <p>Caution! Any deviating number of tightening turns reduces the nominal pressure and the service life of the fitting and may cause leakages or slipping of the fitting.</p>

Ordering Information

Example

1. Tube to Tube Connection

NT	-	12	S	-	S316
①		②	③		⑥

2. Tube to Thread Connection

NMC	-	10 L	-	02G	ED	-	S316
①		② ③		④	⑤		⑥

3. Tube to Tube Port

NEW	-	16 S	-	S316
①		② ③		⑥

4. Tube Port to Female Port

NMGE	-	16 S	-	04G	ED	-	STEL
①		② ③		④	⑤		⑥

5. Male /Female Adapter

NAMF	-	04G	-	03G	-	STEL
①		④				⑥

① Name of Fitting : "Refer to Index"

② Tube O.D. Designator

Tube O.D	4mm	6mm	8mm	38mm	42mm
Identifier	04	06	08	38	42

③ Series Designator

Series	Very Light	Light	Heavy
Identifier	LL	L	S

④-a. Thread Designator (Pipe Thread)

Nominal Size		1/8"	1/4"	3/8"	1/2"	3/4"	1"	1 1/4"	1 1/2"
Identifier	ANSI/ASME B1.20.1 NPT	01N	02N	03N	04N	06N	08N	10N	12N
	DIN-ISO 228(DIN 259) BSP/Parallel	01G	02G	03G	04G	06G	08G	10G	12G
	DIN-2999 BSP Tapered	01R	02R	03R	04R	06R	08R	10R	12R

④-b. Thread Designator (Metric Thread)

Nominal Size		M8X1.0	M10X1.0	M12X1.5	M14X1.5	M27X2.0	M33X2.0	M42X2.0	M48X2.0
Identifier	DIN 158 Taper (Keg)	M8K	M10K	M12K	M14K				
	DIN-13 Parallel	M8X1.0	M10X1.0	M12X1.5	M14X1.5	M27X2.0	M33X2.0	M42X2.0	M48X2.0









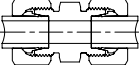

④-c. Thread Designator (Unified)

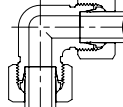
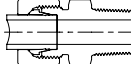
Size	7/16-20UNF	9/16-18UNF	3/4-16UNF	7/8-14UNF	1.1/16-12UN	1.5/16-12UN	1.5/8-12UN
Identifier	4U	6U	8U	10U	12U	16U	20U

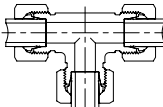
⑤ Elastomer Seal: ED-Ring & O-Ring (Refer to Sealing Material)

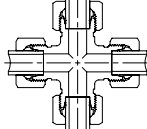
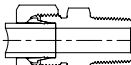
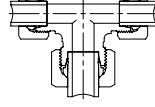
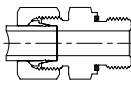
⑥ Material Designator

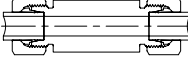
Material	Carbon Steel (DIN 3859)	Stainless Steel		Brass
		DIN 17440/1.4571	ASTM A479 TYPE 316	DIN 17660/17672 MN. 2.0540
Identifier	C	4571	S	B

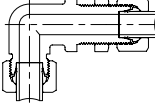
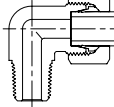
Tube To Tube		EO	EMB	VOLZ	VOSS	WALPRO	Tube To Male Thread		EO	EMB	VOLZ	VOSS	WALPRO
NU Straight Union		G	E	G-V	111... 112...	P-GV	NOM-U/M Male Connector (Unified and Metric Parallel) with O-Ring		GE- UNF/UN GEO			182...	P-GEV..U P-GEV..M -FO.F
16							22						
NL Union Elbow		W	F	W-V	119... 120...	P-WV	NMC-R Male Connector (BSP Tapered)		GE-R	AP-R	GE-V..RK	103... 104...	P-GEV..RK
16							23, 24						
NUR Reducing Union		GR		GR-V		P-GV	NMC-G Male Connector (BSP Parallel)		GE-R	AP	GE-V..R	110...	P-GEV..R
17							23, 24						
NT Union Tee		T	G	T-V	133... 134...	P-TV	NMC-M Male Connector (Metric Parallel)		GE-M	A-M	GE-V..M	109...	P-GEV..M
18							25						
NX Union Cross		K	H	K-V	135... 136...	P-KV	NMC-MK Male Connector (Metric Taper)		GE-M	A-M	GE-V..M	109...	P-GEV..M
18							25						
NTR Reducing Tee		TR				P-TV	NMC-GE Male Connector (BSP Parallel) with ED-Ring		GE-R-ED	A-RWD	GE-V..RWD	184...	P-GEV..R-WD
19							26						
NBU Bulkhead Union		SV	K	GS-V	137...	P-GSV	NMC-ME Male Connector (Metric Parallel) with ED-Ring		GE-M-ED	A-MWD	GE-V..MWD	184...	P-GEV..M-WD
20							27						
NBUW Welding Bulkhead Union		ESV	N	ES-V	141...	P-ESV	NMC-N Male Connector (NPT Thread)		GE-NPT	A/NPT	GE-V..NPT	105...106	P-GEV..NPT
20							28						
NBL Bulkhead Union Elbow		WSV	L	WS-V	138...	P-WSV	NLM-R/M Male Elbow (BSP Tapered / Metric Taper)		WE-R -M	B-R -M	WE-V..R ..M	115...116 113...114	P-WEV..RK ..MK
21							29						

Tube To Female Thread	EO	EMB	VOLZ	VOSS	WALPRO	
NFC-G/M Female Connector (BSP Tapered / Metric Parallel) 30		GAI-R -M	AL-R -M	GAIV..R ..M	144... 134...	P-GAV..R ..M

Tube Stud To Female Port	EO	EMB	VOLZ	VOSS	WALPRO	
NA-GE / ME Adaptor (BSP Tapered / Metric Parallel) with ED-Ring 31		EVGE-R-ED -M-ED	VA-Rwd -Mwd	EG- V..RWD ..MWD	177... 174...	P-EGES.. R-WD-SV M-WD-SV
NEGE-GE / ME Swivel Adaptor (BSP Tapered / Metric Parallel) with ED-Ring 32		EVGE-R-ED -M-ED	VADKO -Rwd -Mwd	EGVD ..RWD ..MWD		EGESD.. R-WD M-WD

Tube To Tube (Swivel)	EO	EMB	VOLZ	VOSS	WALPRO	
NUE Swivel Union with Cone 33		GAI-R -M	AL-R -M	GAIV..R ..M	144... 134...	P-GAV..R ..M

Weld Fittings	EO	EMB	VOLZ	VOSS	WALPRO	
NAS Welding Connector 34		AS	V	GAS-V	139..	P-ASV
NASK Welding Connector with NC 34		AS	ESNO	ASKK ..OD		
NC Welding Nipple with O-ring 35		SKA	SNO	SK-A ..OD	070..	SN
NCR Reducing Welding Nipple with O-ring 35		SKAR	SNR			

Tube To Tube Stud	EO	EMB	VOLZ	VOSS	WALPRO	
NLA Adjustable Elbow with Standpipe 37		EVW	vb	EW-V	158..	P-EWV-SV

NBTA Adjustable Branch Tee with Standpipe 37		EVT	vc	ET-V	160..	P-ETV-SV
---	--	-----	----	------	-------	----------

NRTA Adjustable Run Tee with Standpipe 38		EVL	vd	EL-V	162..	P-ELV-SV
--	--	-----	----	------	-------	----------

NEW Swivel Adjustable Elbow with Cone 38		EW	VBDKO	EWVD		P-EWVD
--	--	----	-------	------	--	--------

NET Swivel Adjustable Branch Tee with Cone 39		ET	VCDKO	ETVD		P-ETVD
--	--	----	-------	------	--	--------

NEL Swivel Adjustable Run Tee with Cone 39		EL	VDDKO	ELVD		P-ELVD
---	--	----	-------	------	--	--------

NKOR Standpipe Reducer 40		KOR	RL, RS			
---	--	-----	--------	--	--	--







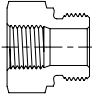
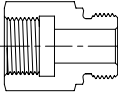
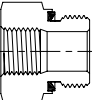
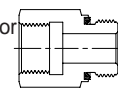
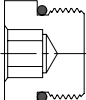
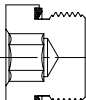
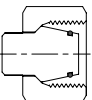
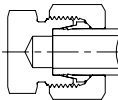

NR Reducer 41				KOR-V	148 ..78	P-REDV-SV
----------------------------	--	--	--	-------	-------------	-----------

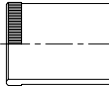
NRED Swivel Reducing Adaptor with Cone 42		RED	RLDKO RSDKO	REDV		P-REDVD
--	--	-----	----------------	------	--	---------

Banjo Fittings	EO	EMB	VOLZ	VOSS	WALPRO
NSLM-G/M Banjo Fitting (BSP Parallel / Metric Parallel) 43		SWVE-R -M	SBD-R -M	152../153.. 150../151..	
NWH-G/M High Pressure Banjo Fitting (BSP Parallel / Metric Parallel) 44			SBE-R -M	EWHV ..R ..M	P-RSWV..R ..M
NTH-G/M High Pressure Banjo Fitting (BSP Parallel / Metric Parallel) 45				ETHV ..R ..M	P-RSTV..R ..M
NSVW-G/M Throttlefree Banjo Fitting (BSP Parallel / Metric Parallel) 46		DSVW-R -M	SB-R -M		
NSVT-G/M Throttlefree Banjo Fitting (BSP Parallel / Metric Parallel) 47		DSVT-R -M	SG-R -M		
Gauge Connector	EO	EMB	VOLZ	VOSS	WALPRO
NGC-G Pressure Gauge Connector (BSP Parallel) 48	MAV	O	MA-V..R	142..	V-MAV..R
NGE-G Swivel Gauge Connector (BSP Parallel) 48	MAVEV	VODK	MAVD..R		EMASD..
NGA-G Gauge Adaptor (BSP Parallel) 48			MAEV..R		P-EMAS ..R-SV

Non Return Valves	EO	EMB	VOLZ	VOSS	WALPRO
NGMA Tee Test Coupling with Threaded Connection 49		GMA3			
NEMA Test Coupling with Threaded Connection 49		GEMA3			
Non Return Valves	EO	EMB	VOLZ	VOSS	WALPRO
NCVU Non Return Valves 50	RHD	RD	RS-V	600..	P-RV
NCV GE-L/S NCV ME-L/S Non Return Valves 51	RHV-R-ED -M-ED	RV-Rwd -Mwd	RSV ..RWD ..MWD	602.. 601..	P-RV ..R-WD ..M-WD
NCV L/S-GE NCV L/S-ME Non Return Valves 52	RHZ-R-ED -M-ED	RZ-Rwd -Mwd	RSVZ ..RWD ..MWD	604.. 603..	P-RVZ ..R-WD ..M-WD

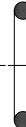
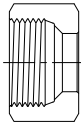
Male & Female Adaptors	EO	EMB	VOLZ	VOSS	WALPRO	
NHB Male Female Adaptor (BSP Parallel) 53		RI	RI	RIAS	149..	RED
NABMF Male Female Adaptor (BSP Parallel) 53		RI	RI	RIBS	149..	RED
NHB-GE Male Female Adaptor (BSP Parallel) with ED-Ring 54		RI-ED	RI-WD	RIAS-WD		RED...WD
NABMF-GE Male Female Adaptor (BSP Parallel) with ED-Ring 54		RI-ED	RI-WD	RIBS-WD		RED...WD
Plugs and Caps	EO	EMB	VOLZ	VOSS	WALPRO	
NVSTI Blanking Plugs with O-Ring for ports 55		VSIT	M-OR			
NVSTI-GED / MED Blanking Plugs with ED-Ring for ports 55		VSIT R-ED M-ED	VSCH-Rwd -Mwd	VSCH..WD	189...	VS-R-WD -M-WD
NP Blanking Plug with O-Ring 56		VKA	STO-O	VSTO..OD		VS...
NCA Tube Cap 56		ROV	VSCHK	EVSV		

Spare Parts	EO	EMB	VOLZ	VOSS	WALPRO	
NIL Tube Insert 57		VH	VSH	VS-H	020..	EH
NBUN Bulkhead Lock Nut 57		GM	GM	G-M	080..	
NKA Sealing Ring for NWH, NTH & NSWVE 57		DKA	DKA	DKRA	080..	
NKAZ Sealing Ring for NSVW, NSVT 57		DKAZ			081..	
NKI Sealing Ring for NGC 57		DKI	DKI	DKRI	080..	DKR
NED ED-Ring 58		ED		WD-R		
NOR O-Ring 58		OR		OD-R		
NN Nut 58		M	m	U-M	004	M
NS Cutting Ring 58		DPR	s	S-DR	007..	S-R P-R

Straight Union
NU

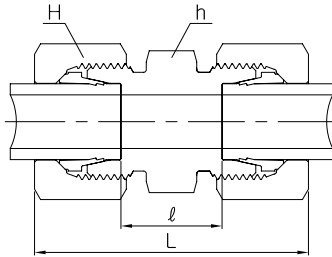

Series	Part No.	Tube O.D	H	h	L	l
LL very light PN 100	NU-04LL	4	10	9	31	12
	NU-06LL	6	12	11	32	9
	NU-08LL	8	14	12	35	12
	NU-10LL	10	17	14	35	12
	NU-12LL	12	19	17	35	11
L light PN 315	NU-06L	6	14	12	39	10
	NU-08L	8	17	14	40	11
	NU-10L	10	19	17	42	13
	NU-12L	12	22	19	43	14
	NU-15L	15	27	24	46	16
	NU-18L	18	32	27	48	16
PN 160	NU-22L	22	36	32	52	20
	NU-28L	28	41	41	54	21
	NU-35L	35	50	46	63	20
	NU-42L	42	60	55	66	21
S heavy PN 630	NU-06S	6	17	14	45	16
	NU-08S	8	19	17	47	18
	NU-10S	10	22	19	49	17
	NU-12S	12	24	22	51	19
	NU-14S	14	27	24	57	22
PN 400	NU-16S	16	30	27	57	21
	NU-20S	20	36	32	66	23
	NU-25S	25	46	41	74	26
	NU-30S	30	50	46	80	27
PN 315	NU-38S	38	60	55	90	29

Union Elbow
NL

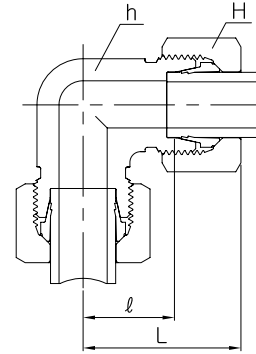

Series	Part No.	Tube O.D	H	h	L	l
LL very light PN 100	NL-04LL	4	10	9	21	11
	NL-06LL	6	12	9	21	9.5
	NL-08LL	8	14	12	23	11.5
	NL-10LL	10	17	14	24	12.5
	NL-12LL	12	19	17	25	13
L light PN 315	NL-06L	6	14	12	27	12
	NL-08L	8	17	12	29	14
	NL-10L	10	19	14	30	15
	NL-12L	12	22	17	32	17
	NL-15L	15	27	19	36	21
	NL-18L	18	32	24	40	23.5
PN 160	NL-22L	22	36	27	44	27.5
	NL-28L	28	41	36	47	30.5
	NL-35L	35	50	41	56	34.5
	NL-42L	42	60	50	63	40
S heavy PN 630	NL-06S	6	17	12	31	16
	NL-08S	8	19	14	32	17
	NL-10S	10	22	17	34	17.5
	NL-12S	12	24	17	38	21.5
	NL-14S	14	27	19	40	22
PN 400	NL-16S	16	30	24	43	24.5
	NL-20S	20	36	27	48	26.5
	NL-25S	25	46	36	54	30
	NL-30S	30	50	41	62	35.5
PN 315	NL-38S	38	60	50	72	41

All dimensions given approx. figure with tighten nut. All dimensions are in millimeters.

Reducing Union NUR

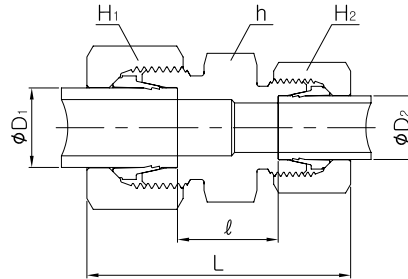

Series	Part No.	Tube O.D		H ₁	H ₂	h	L	l
		D ₁	D ₂					
L light PN 315	NUR08L-06L	8	6	17	14	14	40	11
	NUR10L-06L	10	6	19	14	17	41	12
	NUR10L-08L	10	8	19	17	17	41	12
	NUR12L-06L	12	6	22	14	19	42	13
	NUR12L-08L	12	8	22	17	19	42	13
	NUR12L-10L	12	10	22	19	19	43	14
	NUR15L-10L	15	10	27	19	24	45	15
	NUR15L-12L	15	12	27	22	24	45	15
	NUR18L-10L	18	10	32	19	27	46	15.5
	NUR18L-12L	18	12	32	22	27	46	15.5
PN 160	NUR18L-15L	18	15	32	27	27	48	16.5
	NUR22L-12L	22	12	36	22	32	48	17.5
	NUR22L-15L	22	15	36	27	32	50	18.5
	NUR22L-18L	22	18	36	32	32	50	18
	NUR28L-18L	28	18	41	32	41	52	19
	NUR28L-22L	28	22	41	36	41	54	21
	NUR35L-22L	35	22	50	36	46	59	21
S heavy PN 630	NUR35L-28L	35	28	50	41	46	59	21
	NUR08S-06S	8	6	19	17	17	47	18
	NUR10S-06S	10	6	22	17	19	48	17.5
	NUR10S-08S	10	8	22	19	19	48	17.5
	NUR12S-06S	12	6	24	17	22	50	19.5
	NUR12S-08S	12	8	24	19	22	50	19.5
	NUR12S-10S	12	10	24	22	22	51	19
	NUR14S-10S	14	10	27	22	24	54	20.5
PN 400	NUR14S-12S	14	12	27	24	24	54	20.5
	NUR16S-12S	16	12	30	24	27	54	20
	NUR16S-14S	16	14	30	27	27	57	21.5
	NUR20S-10S	20	10	36	22	32	60	22
	NUR20S-12S	20	12	36	24	32	60	22
	NUR20S-16S	20	16	36	30	32	63	23
	NUR25S-16S	25	16	46	30	41	68	25
	NUR25S-20S	25	20	46	36	41	71	25.5
PN 315	NUR30S-20S	30	20	50	36	46	74	26
	NUR30S-25S	30	25	50	46	46	77	26.5
PN 315	NUR38S-30S	38	30	60	50	55	87	29.5

All dimensions given approx. figure with tighten nut. All dimensions are in millimeters.

Union Tee
NT

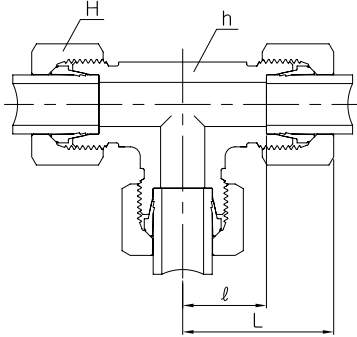

Union Cross
NX

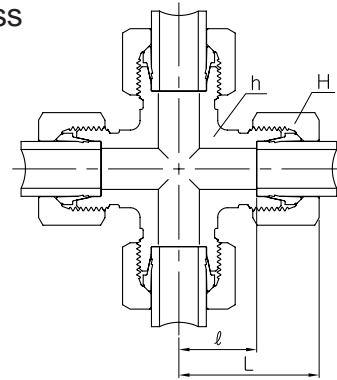

Series	Part No.	Tube O.D	H	h	L	l
LL very light PN 100	NT-04LL	4	10	9	21	11
	NT-06LL	6	12	9	21	9.5
	NT-08LL	8	14	12	23	11.5
	NT-10LL	10	17	14	24	12.5
	NT-12LL	12	19	14	27	15
L light PN 315	NT-06L	6	14	12	27	12
	NT-08L	8	17	12	29	14
	NT-10L	10	19	14	30	15
	NT-12L	12	22	17	32	17
	NT-15L	15	27	19	36	21
	NT-18L	18	32	24	40	23.5
PN 160	NT-22L	22	36	27	44	27.5
	NT-28L	28	41	36	47	30.5
	NT-35L	35	50	41	56	34.5
	NT-42L	42	60	50	63	40
S heavy PN 630	NT-06S	6	17	12	31	16
	NT-08S	8	19	14	32	17
	NT-10S	10	22	17	34	17.5
	NT-12S	12	24	17	38	21.5
	NT-14S	14	27	19	40	22
PN 400	NT-16S	16	30	24	43	24.5
	NT-20S	20	36	27	48	26.5
	NT-25S	25	46	36	54	30
	NT-30S	30	50	41	62	35.5
PN 315	NT-38S	38	60	50	72	41

Series	Part No.	Tube O.D	H	h	L	l
LL very light PN 100	NX-04LL	4	10	9	21	11
	NX-06LL	6	12	9	21	9.5
	NX-08LL	8	14	12	23	11.5
	NX-10LL	10	17	14	24	12.5
	NX-12LL	12	19	14	27	15
L light PN 315	NX-06L	6	14	12	27	12
	NX-08L	8	17	12	29	14
	NX-10L	10	19	14	30	15
	NX-12L	12	22	17	32	17
	NX-15L	15	27	19	36	21
	NX-18L	18	32	24	40	23.5
PN 160	NX-22L	22	36	27	44	27.5
	NX-28L	28	41	36	47	30.5
	NX-35L	35	50	41	56	34.5
	NX-42L	42	60	50	63	40
S heavy PN 630	NX-06S	6	17	12	31	16
	NX-08S	8	19	14	32	17
	NX-10S	10	22	17	34	17.5
	NX-12S	12	24	17	38	21.5
	NX-14S	14	27	19	40	22
PN 400	NX-16S	16	30	24	43	24.5
	NX-20S	20	36	27	48	26.5
	NX-25S	25	46	36	54	30
	NX-30S	30	50	41	62	35.5
PN 315	NX-38S	38	60	50	72	41

All dimensions given approx. figure with tighten nut. All dimensions are in millimeters.

DK DIN Bite Type Tube Fitting

Reducing Tee NTR

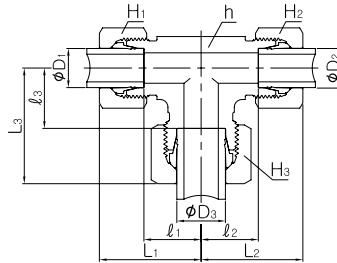

Series	Part No.	Tube O.D			H ₁	H ₂	H ₃	h	L ₁	L ₂	L ₃	ℓ ₁	ℓ ₂	ℓ ₃
		D ₁	D ₂	D ₃										
L light	NTR06L-06L-08L	6	6	8	14	14	17	14	29	29	29	14	14	14
PN 316	NTR08L-08L-06L	8	8	6	17	17	14	14	29	29	29	14	14	14
PN 315	NTR06L-06L-10L	6	6	10	14	14	19	14	30	30	30	15	15	15
	NTR08L-08L-10L	8	8	10	17	17	19	14	30	30	30	15	15	15
	NTR10L-10L-06L	10	10	6	19	19	14	14	30	30	30	15	15	15
	NTR10L-10L-08L	10	10	8	19	19	17	14	30	30	30	15	15	15
	NTR10L-06L-10L	10	6	10	19	14	19	14	30	30	30	15	15	15
PN 315	NTR08L-08L-12L	8	8	12	17	17	22	17	32	32	32	17	17	17
	NTR12L-12L-06L	12	12	6	22	22	14	17	32	32	32	17	17	17
	NTR12L-08L-08L	12	8	8	22	17	17	17	32	32	32	17	17	17
	NTR12L-12L-08L	12	12	8	22	22	17	17	32	32	32	17	17	17
	NTR12L-10L-10L	12	10	10	22	19	19	17	32	32	32	17	17	17
	NTR12L-12L-10L	12	12	10	22	22	19	17	32	32	32	17	17	17
PN 315	NTR12L-10L-12L	12	10	12	22	19	22	17	32	32	32	17	17	17
	NTR10L-10L-15L	10	10	15	19	19	27	19	36	36	36	21	21	21
	NTR12L-12L-15L	12	12	15	22	22	27	19	36	36	36	21	21	21
	NTR15L-15L-06L	15	15	6	27	27	14	19	36	36	36	21	21	21
	NTR15L-15L-10L	15	15	10	27	27	19	19	36	36	36	21	21	21
	NTR15L-12L-12L	15	12	12	27	22	22	19	36	36	36	21	21	21
PN 315	NTR15L-15L-12L	15	15	12	27	27	22	19	36	36	36	21	21	21
	NTR15L-12L-15L	15	12	15	27	22	27	19	36	36	36	21	21	21
	NTR12L-12L-18L	12	12	18	22	22	32	24	39	39	40	24	24	23.5
	NTR18L-10L-10L	18	10	10	32	19	19	24	40	39	39	23.5	24	24
	NTR18L-18L-10L	18	18	10	32	32	19	24	40	40	39	23.5	23.5	24
	NTR18L-18L-12L	18	18	12	32	32	22	24	40	40	39	23.5	23.5	24
PN 160	NTR18L-18L-15L	18	18	15	32	32	27	24	40	40	39	23.5	23.5	24
	NTR18L-10L-18L	18	10	18	32	19	32	24	40	39	40	23.5	24	23.5
	NTR22L-22L-10L	22	22	10	36	36	19	27	44	44	43	27.5	27.5	28
	NTR22L-22L-12L	22	22	12	36	36	22	27	44	44	43	27.5	27.5	28
	NTR22L-15L-15L	22	15	15	36	27	27	27	44	43	43	27.5	28	28
	NTR22L-22L-15L	22	22	15	36	36	27	27	44	44	43	27.5	27.5	28
PN 160	NTR22L-18L-18L	22	18	18	36	32	32	27	44	44	44	27.5	27.5	27.5
	NTR22L-22L-18L	22	22	18	36	36	32	27	44	44	44	27.5	27.5	27.5
	NTR22L-18L-22L	22	18	22	36	32	36	27	44	44	44	27.5	27.5	27.5
	NTR28L-28L-10L	28	28	10	41	41	19	36	47	44	46	30.5	30.5	31
	NTR28L-28L-12L	28	28	12	41	41	22	36	47	47	46	30.5	30.5	31
	NTR28L-28L-15L	28	28	15	41	41	27	36	47	47	46	30.5	30.5	31
S	NTR28L-28L-18L	28	28	18	41	41	32	36	47	47	47	30.5	30.5	30.5
	NTR28L-22L-22L	28	22	22	41	36	36	36	47	47	47	30.5	30.5	30.5
	NTR28L-28L-22L	28	28	22	41	41	36	36	47	47	47	30.5	30.5	30.5
	NTR10S-10S-06S	10	10	6	22	22	17	17	34	34	33	17.5	17.5	18
	NTR12S-08S-08S	12	8	8	24	19	19	17	38	37	37	21.5	22	22
PN 630	NTR12S-12S-08S	12	12	8	24	24	19	17	38	38	37	21.5	21.5	22
	NTR12S-12S-10S	12	12	10	24	24	22	17	38	38	38	21.5	21.5	21.5
	NTR12S-12S-16S	12	12	16	24	24	30	24	42	42	43	25.5	25.5	25.5
	NTR16S-16S-06S	16	16	6	30	30	17	24	43	43	41	24.5	24.5	26
PN 400	NTR16S-16S-08S	16	16	8	30	30	19	24	43	43	41	24.5	24.5	26
	NTR16S-16S-10S	16	16	10	30	30	22	24	43	43	42	24.5	24.5	25.5
	NTR16S-16S-12S	16	16	12	30	30	24	24	43	43	42	24.5	24.5	25.5
	NTR16S-16S-20S	16	16	20	30	30	36	27	47	47	48	28.5	28.5	26.5
PN 400	NTR20S-20S-10S	20	20	10	36	36	22	27	48	48	46	26.5	26.5	29.5
	NTR20S-20S-12S	20	20	12	36	36	24	27	48	48	46	26.5	26.5	29.5
	NTR20S-20S-16S	20	20	16	36	36	30	27	48	48	47	26.5	26.5	28.5
PN 400	NTR20S-20S-25S	20	20	25	36	36	46	36	53	53	54	31.5	31.5	30
	NTR25S-25S-16S	25	25	16	46	46	30	36	54	54	52	30	30	33.5
	NTR25S-25S-20S	25	25	20	46	46	36	36	54	54	53	30	30	31.5
PN 400	NTR25S-25S-30S	25	25	30	46	46	50	41	61	61	62	37	37	35.5

All dimensions given approx. figure with tighten nut. All dimensions are in millimeters.

Bulkhead Union NBU

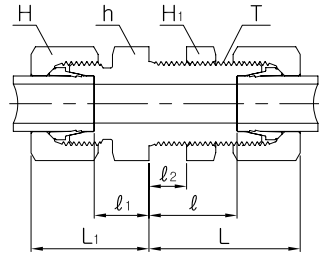
* $l_2 = \text{max. } 16 \text{ mm}$

Series	Part No.	Tube O.D	H	H ₁	h	L	L ₁	ℓ	ℓ ₁	T
L light PN 315	NBU-06L	6	14	17	17	42	22	27	7	M 12 x 1.5
	NBU-08L	8	17	19	19	42	23	27	8	M 14 x 1.5
	NBU-10L	10	19	22	22	43	25	28	10	M 16 x 1.5
	NBU-12L	12	22	24	24	44	25	29	10	M 18 x 1.5
	NBU-15L	15	27	30	27	46	27	31	12	M 22 x 1.5
PN 160	NBU-18L	18	32	36	32	49	30	32.5	13.5	M 26 x 1.5
	NBU-22L	22	36	41	36	51	33	34.5	16.5	M 30 x 2
	NBU-28L	28	41	46	41	52	35	35.5	18.5	M 36 x 2
	NBU-35L	35	50	55	50	58	40	36.5	18.5	M 45 x 2
S heavy PN 630	NBU-42L	42	60	65	60	59	42	36	19	M 52 x 2
	NBU-06S	6	17	19	19	44	27	29	12	M 14 x 1.5
	NBU-08S	8	19	22	22	44	28	29	13	M 16 x 1.5
	NBU-10S	10	22	24	24	46	31	29.5	14.5	M 18 x 1.5
	NBU-12S	12	24	27	27	47	31	30.5	14.5	M 20 x 1.5
PN 400	NBU-14S	14	27	30	30	50	35	32	17	M 22 x 1.5
	NBU-16S	16	30	32	32	50	35	31.5	16.5	M 24 x 1.5
	NBU-20S	20	36	41	41	55	39	33.5	17.5	M 30 x 2
	NBU-25S	25	46	46	46	59	44	35	20	M 36 x 2
PN 315	NBU-30S	30	50	50	50	64	48	37.5	21.5	M 42 x 2
	NBU-38S	38	60	65	65	68	53	37	22	M 52 x 2

All dimensions given approx. figure with tighten nut. All dimensions are in millimeters.

Welding Bulkhead Union NBUW

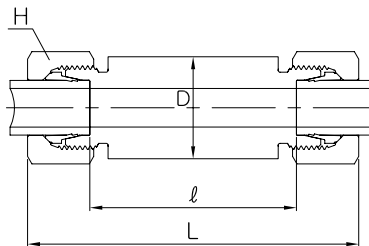

Series	Part No.	Tube O.D	D	H	L	ℓ
L light PN 315	NBUW-06L	6	18	14	85	56
	NBUW-08L	8	20	17	85	56
	NBUW-10L	10	22	19	87	58
	NBUW-12L	12	25	22	87	58
	NBUW-15L	15	28	27	100	70
PN 315	NBUW-18L	18	32	32	101	69
	NBUW-22L	22	36	36	105	73
	NBUW-28L	28	40	41	106	73
	NBUW-35L	35	50	50	114	71
S heavy PN 630	NBUW-42L	42	60	60	115	70
	NBUW-06S	6	20	17	89	60
	NBUW-08S	8	22	19	89	60
	NBUW-10S	10	25	22	91	59
PN 400	NBUW-12S	12	28	24	91	59
	NBUW-14S	14	30	27	107	72
	NBUW-16S	16	35	30	107	71
	NBUW-20S	20	38	36	114	71
PN 315	NBUW-25S	25	45	46	120	72
	NBUW-30S	30	50	50	126	73
	NBUW-38S	38	60	60	133	72

All dimensions given approx. figure with tighten nut. All dimensions are in millimeters.

Bulkhead Union Elbow NBL

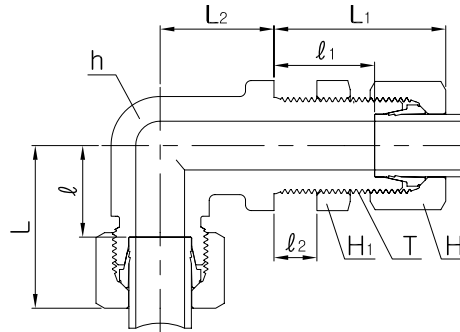

* $l_2 = \text{max. } 16 \text{ mm}$

Series	Part No.	Tube O.D	H	H ₁	h	L	L ₁	L ₂	ℓ	ℓ ₁	T
L light PN 315	NBL-06L	6	14	17	12	27	42	14	12	27	M 12 x 1.5
	NBL-08L	8	17	19	12	29	42	17	14	27	M 14 x 1.5
	NBL-10L	10	19	22	14	30	43	18	15	28	M 16 x 1.5
	NBL-12L	12	22	24	17	32	44	20	17	29	M 18 x 1.5
	NBL-15L	15	27	30	19	36	46	23	21	31	M 22 x 1.5
PN 160	NBL-18L	18	32	36	24	40	49	24	23.5	32.5	M 26 x 1.5
	NBL-22L	22	36	41	27	44	51	30	27.5	34.5	M 30 x 2
	NBL-28L	28	41	46	36	47	52	34	30.5	35.5	M 36 x 2
	NBL-35L	35	50	55	41	56	58	39	34.5	36.5	M 45 x 2
S heavy PN 630	NBL-42L	42	60	65	50	63	59	43	40	36	M 52 x 2
	NBL-06S	6	17	19	12	31	44	17	16	29	M 14 x 1.5
	NBL-08S	8	19	22	14	32	44	18	17	29	M 16 x 1.5
	NBL-10S	10	22	24	17	34	46	20	17.5	29.5	M 18 x 1.5
	NBL-12S	12	24	27	17	38	47	21	21.5	30.5	M 20 x 1.5
PN 400	NBL-14S	14	27	30	19	40	50	23	22	32	M 22 x 1.5
	NBL-16S	16	30	32	24	43	50	24	24.5	31.5	M 24 x 1.5
	NBL-20S	20	36	41	27	48	55	30	26.5	33.5	M 30 x 2
	NBL-25S	25	46	46	36	54	59	34	30	35	M 36 x 2
PN 315	NBL-30S	30	50	50	41	62	64	39	35.5	37.5	M 42 x 2
	NBL-38S	38	60	65	50	72	68	43	41	37	M 52 x 2

All dimensions given approx. figure with tighten nut. All dimensions are in millimeters.

Male Connector
(Unified and Metric Parallel)
with *O-Ring
NOM-U/M

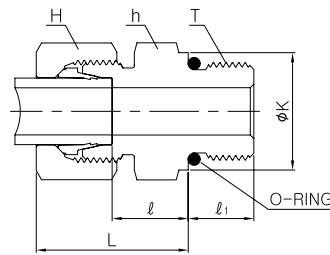

* DIN 3852 Form "F" stud end
* O-ring of NBR standard, of FPM on request

for Unified

Series	Part No.	Tube O.D	H	h	K	L	l ₁	l	T U(Unified)	
L light PN 315	NOM 08L-4U	8	17	17	14.4	25	9	10	7/16-20 UNF-2A	
	NOM 10L-4U	10	19	17	14.4	26	10	11	7/16-20 UNF-2A	
	NOM 12L-6U	12	22	19	17.6	26	10	11	9/16-18 UNF-2A	
	NOM 12L-8U	12	22	24	22.3	28	11	13	3/4-16 UNF-2A	
	NOM 12L-10U	12	22	27	25.5	29	12.7	14.3	7/8-14 UNF-2A	
	NOM 15L-8U	15	27	24	22.3	29	11	14	3/4-16 UNF-2A	
	NOM 15L-10U	15	27	27	25.5	30	12.7	15.3	7/8-14 UNF-2A	
	NOM 18L-8U	18	32	27	22.3	31	11	14.5	3/4-16 UNF-2A	
	NOM 18L-10U	18	32	27	25.5	31	12.7	14.8	7/8-14 UNF-2A	
	PN 160	NOM 22L-10U	22	36	32	25.5	33	12.7	16.8	7/8-14 UNF-2A
		NOM 22L-12U	22	36	32	31.9	33	15	16.5	1 1/16-12 UN-2A
		NOM 22L-16U	22	36	41	38.2	34	15	17.5	1 5/16-12 UN-2A
		NOM 28L-12U	28	41	41	31.9	34	15	17.5	1 1/16-12 UN-2A
		NOM 28L-16U	28	41	41	38.2	34	15	17.5	1 5/16-12 UN-2A
NOM 35L-16U		35	50	46	38.2	39	15	17.5	1 5/16-12 UN-2A	
NOM 35L-20U		35	50	50	47.7	39	15	17.5	1 5/8-12 UN-2A	
NOM 42L-20U		42	60	55	47.7	42	15	19	1 5/8-12 UN-2A	
S heavy PN630	NOM 08S-4U	8	19	17	16	30	9	15	7/16-20 UNF-2A	
	NOM 10S-6U	10	22	19	17.6	31	10	14.5	9/16-18 UNF-2A	
	NOM 12S-6U	12	24	22	17.6	31	10	14.5	9/16-18 UNF-2A	
	NOM 12S-8U	12	24	24	22.3	34	11	17.5	3/4-16 UNF-2A	
PN 400	NOM 16S-8U	16	30	24	22.3	34	11	15.5	3/4-16 UNF-2A	
	NOM 16S-10U	16	30	27	25.5	37	12.7	18.8	7/8-14 UNF-2A	
	NOM 20S-8U	20	36	32	22.3	42	11	20.5	3/4-16 UNF-2A	
	NOM 20S-10U	20	36	32	25.5	42	12.7	20.8	7/8-14 UNF-2A	
	NOM 20S-12U	20	36	32	31.9	42	15	20.5	1 1/16-12 UN-2A	
	NOM 25S-12U	25	46	36	31.9	47	15	23	1 1/16-12 UN-2A	
	NOM 25S-16U	25	46	41	38.2	47	15	23	1 5/16-12 UN-2A	
	NOM 30S-16U	30	50	46	38.2	50	15	23.5	1 5/16-12 UN-2A	
	NOM 30S-20U	30	50	50	47.7	50	15	23.5	1 5/8-12 UN-2A	
	PN 315	NOM 38S-20U	38	60	55	47.7	57	15	26	1 5/8-12 UN-2A

for Metric Parallel

Series	Part No.	Tube O.D	H	h	K	L	l ₁	l	T M(Metric)
L light PN 315	NOM 06L-10M10	6	14	14	-	23	10	8.5	M 10 x 1
	NOM 08L-12M15	8	17	17	-	25	11.5	10	M 12 x 1.5
	NOM 10L-14M15	10	19	19	-	26	11.5	11	M 14 x 1.5
	NOM 12L-16M15	12	22	22	-	27	13	12	M 16 x 1.5
	NOM 15L-18M15	15	27	24	-	29	14.5	13.5	M 18 x 1.5
	NOM 18L-22M15	18	32	27	-	30	15.5	14	M 22 x 1.5
PN 160	NOM 22L-26M15	22	36	32	-	32	16	16	M 26 x 1.5
	NOM 28L-33M20	28	41	41	38	34	19	17.5	M 33 x 2
	NOM 35L-42M20	35	50	50	48	39	19.5	17.5	M 42 x 2
S heavy PN630	NOM 06S-12M15	6	17	17	-	27	11.5	12	M 12 x 1.5
	NOM 08S-14M15	8	19	19	-	27	11.5	12	M 14 x 1.5
	NOM 10S-16M15	10	22	22	-	29	13	12.5	M 16 x 1.5
	NOM 12S-18M15	12	24	24	-	29	14.5	13	M 18 x 1.5
PN 400	NOM 16S-22M15	16	30	27	-	33	15.5	15	M 22 x 1.5
	NOM 20S-27M20	20	36	32	-	37	19	15	M 27 x 2
	NOM 25S-33M20	25	46	41	38	41	19	17	M 33 x 2
	NOM 30S-42M20	30	50	50	48	45	19.5	18.5	M 42 x 2

All dimensions given approx. figure with tighten nut. All dimensions are in millimeters.

Male Connector(BSP Tapered) NMC-R

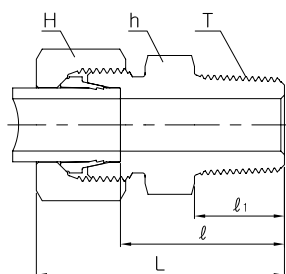

* DIN 3852 Form "C" stud end

Male Connector(BSP Parallel) NMC-G

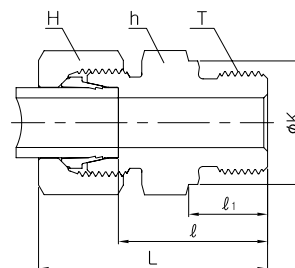

* DIN 3852 Form "B" stud end

Series	Part No.	Tube O.D	H	h	K	L	l	l ₁	T R(PT), G(PF)
LL very light PN 100	NMC 04LL-01R	4	10	11	-	26	16	8	PT 1/8
	NMC 06LL-01R	6	12	11	-	26	14.5	8	PT 1/8
	NMC 08LL-01R	8	14	12	-	28	16.5	8	PT 1/8
	NMC 08LL-02R	8	14	14	-	32	20.5	12	PT 1/4
	NMC 10LL-02R	10	17	14	-	32	20.5	12	PT 1/4
	NMC 12LL-02R	12	19	17	-	32	20	12	PT 1/4
	NMC 12LL-03R	12	19	17	-	32	20	12	PT 3/8
L light PN 315	NMC 06L-01G	6	14	14	14	23	8.5	8	PF 1/8
	NMC 06L-01R	6	14	12	-	30	15	8	PT 1/8
	NMC 06L-02G	6	14	19	18	25	10	12	PF 1/4
	NMC 06L-03G	6	14	22	22	26	11.5	12	PF 3/8
	NMC 06L-04G	6	14	27	26	27	12	14	PF 1/2
	NMC 08L-01G	8	17	14	14	23	8.5	8	PF 1/8
	NMC 08L-02G	8	17	19	18	25	10	12	PF 1/4
	NMC 08L-02R	8	17	17	-	35	20	12	PT 1/4
	NMC 08L-03G	8	17	22	22	26	11.5	12	PF 3/8
	NMC 08L-04G	8	17	27	26	27	12	14	PF 1/2
	NMC 10L-02G	10	19	19	18	26	11	12	PF 1/4
	NMC 10L-02R	10	19	17	-	36	21	12	PT 1/4
	NMC 10L-03G	10	19	22	22	27	12.5	12	PF 3/8
	NMC 10L-04G	10	19	27	26	28	13	14	PF 1/2
	NMC 12L-02R	12	22	19	-	37	22	12	PF 1/4
	NMC 12L-02G	12	22	19	18	27	12	12	PT 1/4
	NMC 12L-03G	12	22	22	22	27	12.5	12	PF 3/8
	NMC 12L-03R	12	22	19	-	37	22	12	PT 3/8
	NMC 12L-04G	12	22	27	26	28	13	14	PF 1/2
	NMC 12L-04R	12	22	24	-	39	24	14	PT 1/2
	NMC 12L-06G	12	22	32	32	29	14	16	PF 3/4
	NMC 15L-03R	15	27	24	-	38	23	12	PT 3/8
	NMC 15L-03G	15	27	24	22	29	13.5	12	PF 3/8
	NMC 15L-04G	15	27	27	26	29	14	14	PF 1/2
NMC 15L-04R	15	27	24	-	40	25	14	PT 1/2	
NMC 15L-06G	15	27	32	32	30	15	16	PF 3/4	
NMC 18L-03G	18	32	27	22	29.5	14	12	PF 3/8	
NMC 18L-04G	18	32	27	26	31	14.5	14	PF 1/2	
NMC 18L-04R	18	32	27	-	41	25.5	14	PT 1/2	
NMC 18L-06G	22	32	32	32	30	14.5	16	PF 3/4	

All dimensions given approx. figure with tighten nut. All dimensions are in millimeters.

Male Connector(BSP Tapered) NMC-R

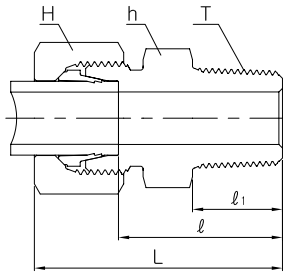

* DIN 3852 Form "C" stud end

Male Connector(BSP Parallel) NMC-G

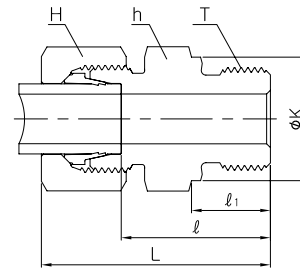

* DIN 3852 Form "B" stud end

Series	Part No.	Tube O.D	H	h	K	L	ℓ	ℓ ₁	T R(PT), G(PF)
L light PN 160	NMC 22L-06G	22	36	32	32	33	16.5	16	PF 3/4
	NMC 22L-04G	22	36	32	26	33	16.5	14	PF 1/2
	NMC 22L-06R	22	36	32	-	46	29.5	16	PT 3/4
	NMC 28L-08G	28	41	41	39	34	17.5	18	PF 1
	NMC 28L-06G	28	41	41	32	34	17.5	16	PF 3/4
	NMC 35L-08G	35	50	46	39	39	17.5	18	PF 1
	NMC 35L-10G	35	50	50	49	39	17.5	20	PF 1 1/4
	NMC 42L-12G	42	60	55	55	42	19	22	PF 1 1/2
S heavy PB 630	NMC 06S-02G	6	17	19	18	28	13	12	PF 1/4
	NMC 06S-04G	6	17	27	26	33	18	14	PF 1/2
	NMC 08S-02G	8	19	19	18	30	15	12	PF 1/4
	NMC 08S-03G	8	19	22	22	30	15.5	12	PF 3/8
	NMC 10S-02G	10	22	19	18	31	14.5	12	PF 1/4
	NMC 10S-03G	10	22	22	22	31	15	12	PF 3/8
	NMC 10S-04G	10	22	27	26	34	17.5	14	PF 1/2
	NMC 12S-02G	12	24	22	18	33	16.5	12	PF 1/4
	NMC 12S-03G	12	24	22	22	33	17	12	PF 3/8
	NMC 12S-04G	12	24	27	26	34	17.5	14	PF 1/2
	NMC 14S-03G	14	27	24	22	36	18.5	12	PF 3/8
	NMC 14S-04G	14	27	27	26	37	19	14	PF 1/2
PB 400	NMC 16S-04G	16	30	27	26	37	18.5	14	PF 1/2
	NMC 16S-03G	16	30	27	22	36	18	12	PF 3/8
	NMC 16S-06G	16	30	32	32	39	20.5	16	PF 3/4
	NMC 20S-04G	20	36	32	26	42	20.5	14	PF 1/2
	NMC 20S-06G	20	36	32	32	42	20.5	16	PF 3/4
	NMC 25S-08G	25	46	41	39	47	23	18	PF 1
	NMC 25S-06G	25	46	41	32	47	23	16	PF 3/4
	NMC 30S-08G	30	50	46	39	50	23.5	18	PF 1
PB 250	NMC 30S-10G	30	50	50	49	50	23.5	20	PF 1 1/4
	NMC 38S-10G	38	60	55	49	57	26	20	PF 1 1/4
	NMC 38S-12G	38	60	55	55	57	26	22	PF 1 1/2

All dimensions given approx. figure with tighten nut. All dimensions are in millimeters.

DK DIN Bite Type Tube Fitting

Male Connector(Metric Parallel) NMC-M

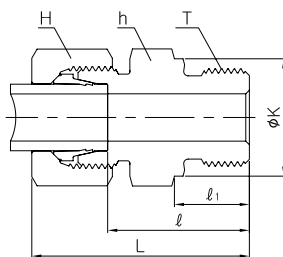

* DIN 3852 Form "B" stud end

Series	Part No.	Tube O.D	H	h	K	L	l	l ₁	T M(Metric)
L light PN 315	NMC 06L-10M10	6	14	14	14	23	8.5	8	M 10 x 1
	NMC 08L-12M15	8	17	17	17	25	10	12	M 12 x 1.5
	NMC 08L-18M15	8	17	24	23	26	11.5	12	M 18 x 1.5
	NMC 10L-14M15	10	19	19	19	26	11	12	M 14 x 1.5
	NMC 10L-16M15	10	19	22	21	27	12	12	M 16 x 1.5
	NMC 10L-18M15	10	19	24	23	27	12.5	12	M 18 x 1.5
	NMC 10L-22M15	10	19	27	27	29	14	14	M 22 x 1.5
	NMC 12L-14M15	12	22	19	19	26	11	12	M 14 x 1.5
	NMC 12L-16M15	12	22	22	21	27	12.5	12	M 16 x 1.5
	NMC 12L-18M15	12	22	24	23	27	12.5	12	M 18 x 1.5
	NMC 12L-22M15	12	22	27	27	29	14	14	M 22 x 1.5
	NMC 15L-16M15	15	27	24	21	28	13	12	M 16 x 1.5
	NMC 15L-18M15	15	27	24	23	29	13.5	12	M 18 x 1.5
	NMC 15L-22M15	15	27	27	27	30	15	14	M 22 x 1.5
	NMC 18L-18M15	18	32	27	23	30	14	12	M 18 x 1.5
NMC 18L-22M15	18	32	27	27	31	14.5	14	M 22 x 1.5	
PN 160	NMC 22L-22M15	22	36	32	27	33	16.5	14	M 22 x 1.5
	NMC 22L-26M15	22	36	32	31	33	16.5	16	M 26 x 1.5
	NMC 28L-33M20	28	41	41	39	34	17.5	18	M 33 x 2
	NMC 35L-42M20	35	50	50	49	39	17.5	20	M 42 x 2
	NMC 42L-48M20	42	60	55	55	42	19	22	M 48 x 2
S heavy PB 630	NMC 06S-12M15	6	17	17	17	28	13	12	M 12 x 1.5
	NMC 08S-14M15	8	19	19	19	30	15	12	M 14 x 1.5
	NMC 10S-16M15	10	22	22	21	31	15	12	M 16 x 1.5
	NMC 12S-18M15	12	24	24	23	33	17	12	M 18 x 1.5
	NMC 12S-22M15	12	24	27	27	34	17.5	14	M 22 x 1.5
PB 400	NMC 14S-20M15	14	27	27	25	37	19	14	M 20 x 1.5
	NMC 16S-18M15	16	30	27	23	36	18	12	M 18 x 1.5
	NMC 16S-22M15	16	30	27	27	37	18.5	14	M 22 x 1.5
	NMC 20S-27M20	20	36	32	32	42	20.5	16	M 27 x 2
PB 250	NMC 25S-33M20	25	46	41	39	47	23	18	M 33 x 2
	NMC 30S-42M20	30	50	50	49	50	23.5	20	M 42 x 2
	NMC 38S-48M20	38	60	55	55	57	26	22	M 48 x 2

All dimensions given approx. figure with tighten nut. All dimensions are in millimeters.

Male Connector(Metric Tapered) NMC-MK

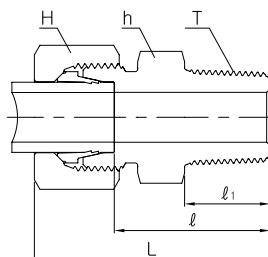

* DIN 3852 Form "C" stud end

Series	Part No.	Tube O.D	H	h	K	L	l	l ₁	T M(Metric)
LL very light PN 100	NMC 04LL-6M10K	4	10	9	-	26	16	8	M 6 x 1 Keg
	NMC 04LL-8M10K	4	10	10	-	26	16	8	M 8 x 1 Keg
	NMC 06LL-10M10K	6	12	11	-	26	14.5	8	M10 x 1 Keg
	NMC 08LL-10M10K	8	14	12	-	28	16.5	8	M10 x 1 Keg

All dimensions given approx. figure with tighten nut. All dimensions are in millimeters.

Male Connector(BSP Parallel)
with *ED-Ring
NMC-GE

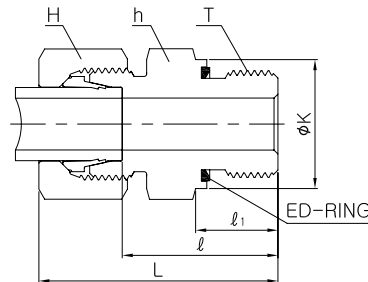

- * DIN 3852 Form "E" stud end
- * ED-ring of NBR standard, of FPM on request

Series	Part No.	Tube O.D	H	h	K	L	l	l ₁	T G (PF)
L light PN 315	NMC 06L-01GE	6	14	14	14	23	8.5	8	1/8
	NMC 06L-02GE	6	14	19	19	25	10	12	1/4
	NMC 08L-01GE	8	17	14	14	24	9.5	8	1/8
	NMC 08L-02GE	8	17	19	19	25	10	12	1/4
	NMC 08L-03GE	8	17	22	22	26	11.5	12	3/8
	NMC 10L-02GE	10	19	19	19	26	11	12	1/4
	NMC 10L-03GE	10	19	22	22	27	12.5	12	3/8
	NMC 10L-04GE	10	19	27	27	28	13	14	1/2
	NMC 12L-02GE	12	22	19	19	27	12	12	1/4
	NMC 12L-03GE	12	22	22	22	27	12.5	12	3/8
	NMC 12L-04GE	12	22	27	27	28	13	14	1/2
	NMC 15L-03GE	15	27	24	22	29	13.5	12	3/8
	NMC 15L-04GE	15	27	27	27	29	14	14	1/2
	NMC 18L-04GE	18	32	27	27	31	14.5	14	1/2
NMC 18L-06GE	18	32	32	32	31	14.5	16	3/4	
PN 160	NMC 22L-06GE	22	36	32	32	33	16.5	16	3/4
	NMC 28L-08GE	28	41	41	40	34	17.5	18	1
	NMC 35L-10GE	35	50	50	50	39	17.5	20	1 1/4
	NMC 42L-12GE	42	60	55	55	42	19	22	1 1/2
S heavy PN 630	NMC 06S-02GE	6	17	19	19	28	13	12	1/4
	NMC 08S-02GE	8	19	19	19	30	15	12	1/4
	NMC 08S-03GE	8	19	22	22	30	15.5	12	3/8
	NMC 10S-02GE	10	22	19	19	31	14.5	12	1/4
	NMC 10S-03GE	10	22	22	22	31	15	12	3/8
	NMC 10S-04GE	10	22	27	27	34	17.5	14	1/2
	NMC 12S-02GE	12	24	22	19	33	16.5	12	1/4
	NMC 12S-03GE	12	24	22	22	33	17	12	3/8
	NMC 12S-04GE	12	24	27	32	34	17.5	14	1/2
	NMC 14S-04GE	14	27	27	27	37	19	14	1/2
PN 400	NMC 16S-03GE	16	30	27	22	36	18	12	3/8
	NMC 16S-04GE	16	30	27	27	37	18.5	14	1/2
	NMC 16S-06GE	16	30	32	27	39	20.5	16	3/4
	NMC 20S-06GE	20	36	32	32	42	20.5	16	3/4
	NMC 25S-04GE	25	46	41	27	47	23	14	1/2
	NMC 25S-06GE	25	46	41	32	47	23	16	3/4
	NMC 25S-08GE	25	46	41	40	47	23	18	1
	NMC 30S-10GE	30	50	50	50	50	23.5	20	1 1/4
PN 315	NMC 38S-12GE	38	60	55	55	57	26	22	1 1/2

All dimensions given approx. figure with tighten nut. All dimensions are in millimeters.

Male Connector(Metric Parallel) with *ED-Ring **NMC-ME**

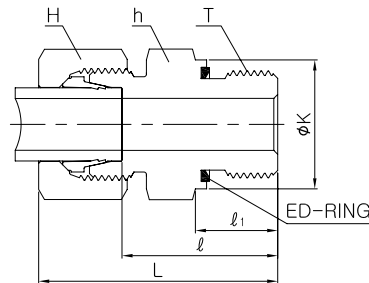

* DIN 3852 Form "E" stud end
* ED-ring of NBR standard, of FPM on request

Series	Part No.	Tube O.D	H	h	K	L	l	l ₁	T M(Metric)
L light PN 315	NMC 06L-10M10E	6	14	14	14	23	8.5	8	M 10 x 1
	NMC 08L-12M15E	8	17	17	17	25	10	12	M 12 x 1.5
	NMC 10L-14M15E	10	19	19	19	26	11	12	M 14 x 1.5
	NMC 12L-16M15E	12	22	22	22	27	12.5	12	M 16 x 1.5
	NMC 12L-18M15E	12	22	24	24	27	12.5	12	M 18 x 1.5
	NMC 12L-22M15E	12	22	27	27	29	14	14	M 22 x 1.5
	NMC 15L-18M15E	15	27	24	24	29	13.5	12	M 18 x 1.5
	NMC 15L-22M15E	15	27	27	27	30	15	14	M 22 x 1.5
PN 160	NMC 18L-22M15E	18	32	27	27	31	14.5	14	M 22 x 1.5
	NMC 22L-26M15E	22	36	32	32	33	16.5	16	M 26 x 1.5
	NMC 28L-33M20E	28	41	41	40	34	17.5	18	M 33 x 2
	NMC 35L-42M20E	35	50	50	50	39	17.5	20	M 42 x 2
S heavy PN 630	NMC 42L-48M20E	42	60	55	55	42	19	22	M 48 x 2
	NMC 06S-12M15E	6	17	17	17	28	13	12	M 12 x 1.5
	NMC 08S-14M15E	8	19	19	19	30	15	12	M 14 x 1.5
	NMC 10S-16M15E	10	22	22	22	31	15	12	M 16 x 1.5
	NMC 12S-18M15E	12	24	24	24	33	17	12	M 18 x 1.5
PN 400	NMC 14S-20M15E	14	27	27	26	37	19	14	M 20 x 1.5
	NMC 16S-22M15E	16	30	27	27	37	18.5	14	M 22 x 1.5
	NMC 20S-27M20E	20	36	32	32	42	20.5	16	M 27 x 2
	NMC 25S-33M20E	25	46	41	40	47	23	18	M 33 x 2
PN 315	NMC 30S-42M20E	30	50	50	50	50	23.5	20	M 42 x 2
	NMC 38S-48M20E	38	60	55	55	57	26	22	M 48 x 2

All dimensions given approx. figure with tighten nut. All dimensions are in millimeters.

Male Connector(NPT Thread) NMC-N

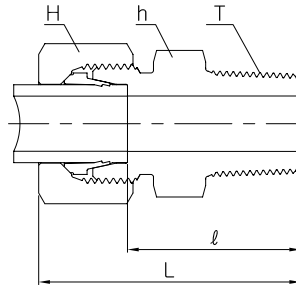

* DIN 3852 Form "C" stud end

Series	Part No.	Tube O.D	H	h	L	ℓ	ℓ ₁	T N(NPT)
LL very light PN 100	NMC 04LL-01N	4	10	11	28	18.5	9.9	1/8-27
	NMC 06LL-01N	6	12	11	28	16.5	9.9	1/8-27
	NMC 08LL-01N	8	14	12	30	18.5	9.9	1/8-27
L light PN 315	NMC 06L-01N	6	14	12	32	17	9.9	1/8-27
	NMC 06L-02N	6	14	17	38	23	14.2	1/4-18
	NMC 08L-02N	8	17	17	38	23	14.2	1/4-18
	NMC 10L-02N	10	19	17	39	24	14.2	1/4-18
	NMC 10L-03N	10	19	19	40	25	14.2	3/8-18
	NMC 12L-02N	12	22	19	40	25	14.2	1/4-18
	NMC 12L-03N	12	22	19	40	25	14.2	3/8-18
	NMC 12L-04N	12	22	22	45	30	19.1	1/2-14
PN 160	NMC 15L-04N	15	27	24	46	31	19.1	1/2-14
	NMC 18L-04N	18	32	27	48	31.5	19.1	1/2-14
	NMC 22L-06N	22	36	32	50	33.5	19.1	3/4-14
	NMC 28L-08N	28	41	41	56	39.5	23.9	1-11.5
S heavy PN 630	NMC 35L-10N	35	50	46	62	40.5	23.9	1 1/4-11.5
	NMC 42L-12N	42	60	55	65	42	25.4	1 1/2-11.5
	NMC 06S-02N	6	17	17	43	28	14.2	1/4-18
	NMC 08S-02N	8	19	17	43	28	14.2	1/4-18
	NMC 10S-02N	10	22	19	44	27.5	14.2	1/4-18
	NMC 10S-03N	10	22	19	44	27.5	14.2	3/8-18
	NMC 12S-02N	12	24	22	46	29.5	14.2	1/4-18
	NMC 12S-03N	12	24	22	46	29.5	14.2	3/8-18
PN 400	NMC 12S-04N	12	24	22	51	34.5	19.1	1/2-14
	NMC 14S-04N	14	27	24	54	36	19.1	1/2-14
	NMC 16S-04N	16	30	27	54	35.5	19.1	1/2-14
	NMC 20S-06N	20	36	32	59	37.5	19.1	3/4-14
PN 315	NMC 25S-08N	25	46	41	69	45	23.9	1-11.5
	NMC 30S-10N	30	50	46	73	46.5	23.9	1 1/4-11.5
	NMC 38S-12N	38	60	55	80	49	25.4	1 1/2-11.5

All dimensions given approx. figure with tighten nut. All dimensions are in millimeters.

Male Elbow (BSP Tapered/Metric Tapered) NLM-R / M

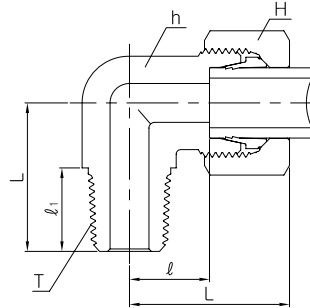

* DIN 3852 Form "C" stud end

Series	Part No.		Tube O.D	H	h	L	L ₁	ℓ	Metric Taper		R(PT)	
									T	ℓ ₁	T	ℓ ₁
LL very light PN 100	NLM 04LL-01R	NLM 04LL-8M10K	4	10	9	21	17	11	M 8x1 Keg	8	1/8	10
	NLM 06LL-01R	NLM 06LL-10M10K	6	12	9	21	17	9.5	M 10x1 Keg	8	1/8	10
	NLM 08LL-01R	NLM 08LL-10M10K	8	14	12	23	20	11.5	M 10x1 Keg	8	1/8	10
	NLM 10LL-02R	-	10	17	14	24	23	12.5	-	-	1/4	14
	NLM 12LL-02R	-	12	19	17	25	23	13	-	-	1/4	14
L light PN 315	NLM 06L-01R	NLM 06L-10M10K	6	14	12	27	20	12	M 10x 1 Keg	8	1/8	10
	NLM 08L-02R	NLM 08L-12M15K	8	17	12	29	26	14	M 12x1.5 Keg	12	1/4	14
	NLM 10L-02R	NLM 10L-14M15K	10	19	14	30	27	15	M 14x1.5 Keg	12	1/4	14
	NLM 12L-03R	NLM 12L-16M15K	12	22	17	32	28	17	M 16x1.5 Keg	14	3/8	15
	NLM 15L-04R	NLM 15L-18M15K	15	27	19	36	34	21	M 18x1.5 Keg	14	1/2	19
	NLM 18L-04R	NLM 18L-22M15K	18	32	24	40	36	23.5	M 22x1.5 Keg	17	1/2	19
S heavy PN 400	NLM 06S-02R	NLM 06S-12M15K	6	17	12	31	26	16	M 12x1.5 Keg	12	1/4	14
	NLM 08S-02R	NLM 08S-14M15K	8	19	14	32	27	17	M 14x1.5 Keg	12	1/4	14
	NLM 10S-03R	NLM 10S-16M15K	10	22	17	34	28	17.5	M 16x1.5 Keg	12	3/8	15
	NLM 12S-03R	NLM 12S-18M15K	12	24	17	38	28	21.5	M 18x1.5 Keg	12	3/8	15
	NLM 14S-04R	NLM 14S-20M15K	14	27	19	40	32	22	M 20x1.5 Keg	14	1/2	19
	NLM 16S-04R	NLM 16S-22M15K	16	30	24	43	32	24.5	M 22x1.5 Keg	17	1/2	19

All dimensions given approx. figure with tighten nut. All dimensions are in millimeters.

Female Connector
(BSP Parallel/Metric Parallel)
NFC-G /M

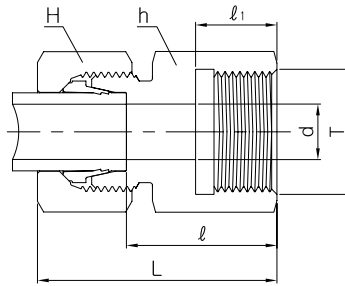

* DIN 3852 Form "Y" stud end

for BSP Parallel

Series	Part No.	Tube O.D	d	H	h	L	ℓ	ℓ ₁	T G(PF)
L light PN 315	NFC 06L-01G	6	4	14	14	34	19	12	1/8
	NFC 08L-02G	8	6	17	19	39	24	17	1/4
	NFC 08L-03G	8	6	17	24	40	25	17	3/8
	NFC 08L-04G	8	6	17	27	44	29	20	1/2
	NFC 10L-02G	10	8	19	19	40	25	17	1/4
	NFC 10L-03G	10	8	19	24	41	26	17	3/8
	NFC 10L-04G	10	8	19	27	45	30	20	1/2
	NFC 12L-03G	12	10	22	24	41	26	17	3/8
	NFC 12L-04G	12	10	22	27	45	30	20	1/2
PB 160	NFC 15L-04G	15	12	27	27	46	31	20	1/2
	NFC 18L-04G	18	15	32	27	47	30.5	20	1/2
	NFC 22L-06G	22	19	36	36	52	35.5	22	3/4
	NFC 28L-08G	28	24	41	41	55	38	24.5	1
	NFC 35L-10G	35	30	50	55	63	41	26.5	1 1/4
S heavy PB630	NFC 42L-12G	42	36	60	60	65	42.5	28.5	1 1/4
	NFC 06S-02G	6	4	17	19	41	26	17	1/4
	NFC 08S-02G	8	5	19	19	41	26	17	1/4
	NFC 10S-03G	10	7	22	24	43	26.5	17	3/8
	NFC 12S-03G	12	8	24	24	43	26.5	17	3/8
PB 400	NFC 14S-04G	14	10	27	30	50	32	20	1/2
	NFC 16S-04G	16	12	30	30	50	31.5	20	1/2
	NFC 20S-06G	20	16	36	36	56	34.5	22	3/4
	NFC 25S-08G	25	20	46	41	62	37.5	24.5	1
PB 315	NFC 30S-10G	30	25	50	55	69	42	26.5	1 1/4
	NFC 38S-12G	38	32	60	60	74	43.5	28.5	1 1/2

for Metric Parallel

Series	Part No.	Tube O.D	d	H	h	L	ℓ	ℓ ₁	T M(Metric)
L light PN 315	NFC 06L-10M10	6	4	14	14	34	19.5	12.5	M 10 x 1
	NFC 08L-12M15	8	6	17	17	39	24	17	M 12 x 1.5
	NFC 10L-14M15	10	8	19	19	40	25	17	M 14 x 1.5
	NFC 12L-16M15	12	10	22	22	41	26	17	M 16 x 1.5
	NFC 15L-18M15	15	12	27	24	43	28	17	M 18 x 1.5
	NFC 18L-22M15	18	15	32	30	46	29.5	19	M 22 x 1.5
PB 160	NFC 22L-26M15	22	19	36	32	51	34.5	21	M 26 x 1.5
	NFC 28L-33M20	28	24	41	41	54	37.5	24	M 33 x 2
	NFC 35L-42M20	35	30	50	55	62	40.5	26	M 42 x 2
	NFC 42L-48M20	42	36	60	60	65	42	28	M 48 x 2
S heavy PB630	NFC 06S-12M15	6	4	17	17	41	26	17	M 12 x 1.5
	NFC 08S-14M15	8	5	19	19	41	26	17	M 14 x 1.5
	NFC 10S-16M15	10	7	22	22	43	26.5	17	M 16 x 1.5
	NFC 12S-18M15	12	8	24	24	44	27.5	17	M 18 x 1.5
	NFC 14S-20M15	14	10	27	27	49	31	19	M 20 x 1.5
PB 400	NFC 16S-22M15	16	12	30	30	49	30.5	19	M 22 x 1.5
	NFC 20S-27M20	20	16	36	36	56	34.5	22	M 27 x 2
	NFC 25S-33M20	25	20	46	41	61	37	24	M 33 x 2
	NFC 30S-42M20	30	25	50	55	68	41.5	26	M 42 x 2
PB 315	NFC 38S-48M20	38	32	60	60	74	43	28	M 48 x 2

All dimensions given approx. figure with tighten nut. All dimensions are in millimeters.

DK DIN Bite Type Tube Fitting

Adapter(BSP Parallel / Metric Parallel)
with *ED-Ring

NA-GE / ME

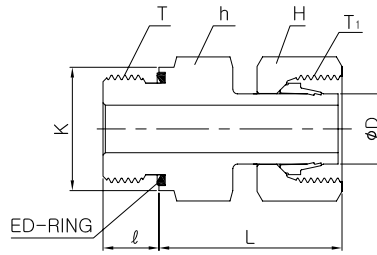

* DIN 3852 Form "E" stud end

* ED-ring of NBR standard, of FPM on request

for BSP Parallel

Series	Part No.	Tube O.D D	H	h	K	L	ℓ	T G(PF)	T ₁
L light PN 315	NA 06L-01GE	6	14	14	14	24.5	8	1/8	M 12 x 1.5
	NA 08L-02GE	8	17	19	19	29.5	12	1/4	M 14 x 1.5
	NA 10L-02GE	10	19	19	19	27.5	12	1/4	M 16 x 1.5
	NA 12L-03GE	12	22	22	22	34	12	3/8	M 18 x 1.5
	NA 15L-04GE	15	27	27	27	32	14	1/2	M 22 x 1.5
NA 18L-04GE	18	32	27	27	27	31.5	14	1/2	M 26 x 1.5
PN 160	NA 22L-06GE	22	36	32	32	32.5	16	3/4	M 30 x 2
	NA 28L-08GE	28	41	41	40	35	18	1	M 36 x 2
	NA 35L-10GE	35	50	50	50	42.5	20	1 1/4	M 45 x 2
	NA 42L-12GE	42	60	55	55	46.5	22	1 1/2	M 52 x 2
S heavy PN 630	NA 06S-02GE	6	17	19	19	27	12	1/4	M 14 x 1.5
	NA 08S-02GE	8	19	19	19	29.5	12	1/4	M 16 x 1.5
	NA 10S-03GE	10	22	22	22	32	12	3/8	M 18 x 1.5
	NA 12S-03GE	12	24	22	22	34	12	3/8	M 20 x 1.5
	NA 12S-04GE	12	24	27	27	34.5	14	1/2	M 20 x 1.5
NA 14S-04GE	14	27	27	27	36.5	14	1/2	M 22 x 1.5	
PN 400	NA 16S-04GE	16	30	27	27	37	14	1/2	M 24 x 1.5
	NA 16S-06GE	16	30	32	32	39	16	3/4	M 24 x 1.5
	NA 20S-06GE	20	36	32	32	43	16	3/4	M 30 x 2
	NA 25S-08GE	25	46	41	40	48	18	1	M 36 x 2
	NA 30S-10GE	30	50	50	50	51	20	1 1/4	M 42 x 2
PN315	NA 38S-12GE	38	60	55	55	60	22	1 1/2	M 52 x 2

for Metric Parallel

Series	Part No.	Tube O.D D	H	h	K	L	ℓ	T M(Metric)	T ₁
L light PN 315	NA 06L-10M10E	6	14	14	14	24.5	8	M 10 x 1	M 12 x 1.5
	NA 08L-12M15E	8	17	17	17	26.5	12	M 12 x 1.5	M 14 x 1.5
	NA 10L-14M15E	10	19	19	19	27.5	12	M 14 x 1.5	M 16 x 1.5
	NA 12L-16M15E	12	22	22	22	30.5	12	M 16 x 1.5	M 18 x 1.5
	NA 15L-18M15E	15	27	24	24	31.5	14	M 18 x 1.5	M 22 x 1.5
NA 18L-22M15E	18	32	27	27	31.5	14	M 22 x 1.5	M 26 x 1.5	
PN 160	NA 22L-26M15E	22	36	32	32	32.5	16	M 26 x 1.5	M 30 x 2
	NA 28L-33M20E	28	41	41	40	35	18	M 33 x 2	M 36 x 2
	NA 35L-42M20E	35	50	50	50	42.5	20	M 42 x 2	M 45 x 2
	NA 42L-48M20E	42	60	55	55	46.5	22	M 48 x 2	M 52 x 2
S heavy PN 630	NA 06S-12M15E	6	17	17	17	27	12	M 12 x 1.5	M 14 x 1.5
	NA 08S-14M15E	8	19	19	19	29.5	12	M 14 x 1.5	M 16 x 1.5
	NA 10S-16M15E	10	22	22	22	32	12	M 16 x 1.5	M 18 x 1.5
	NA 12S-18M15E	12	24	24	24	34	12	M 18 x 1.5	M 20 x 1.5
	NA 12S-20M15E	14	27	27	27	36.5	14	M 20 x 1.5	M 22 x 1.5
PN 400	NA 16S-22M15E	16	30	27	27	37	14	M 22 x 1.5	M 24 x 1.5
	NA 20S-27M20E	20	36	32	32	43	16	M 27 x 2	M 30 x 2
	NA 25S-33M20E	25	46	41	40	48	18	M 33 x 2	M 36 x 2
	NA 30S-42M20E	30	50	50	50	51	20	M 42 x 2	M 42 x 2
PN 315	NA 38S-48M20E	38	60	55	55	60	22	M 48 x 2	M 52 x 2

All dimensions given approx. figure with tighten nut. All dimensions are in millimeters.
Tube stud have to swage for nut and cutting ring. Please see final assembly on page 10.
Nut and cutting ring are not supplied.

Swivel Adapter(BSP Parallel / Metric Parallel)
with Cone and *ED-Ring

NEGE-GE / ME

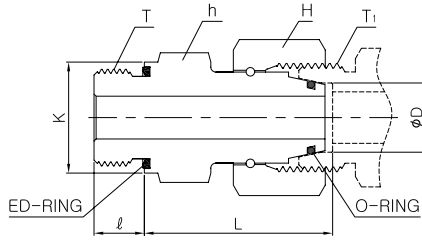

* DIN 3852 Form "E" stud end

* ED-ring and O-ring of NBR standard,
of FPM on request

for BSP Parallel

Series	Part No.	Tube O.D D	H ₁	h	K	L	ℓ	T G(PF)	T ₁
L light PN 315	NEGE 06L-01GE	6	14	14	14	24.5	8	1/8	M 12 x 1.5
	NEGE 08L-02GE	8	17	19	19	29.5	12	1/4	M 14 x 1.5
	NEGE 10L-02GE	10	19	19	19	27.5	12	1/4	M 16 x 1.5
	NEGE 12L-03GE	12	22	22	22	34	12	3/8	M 18 x 1.5
	NEGE 15L-04GE	15	27	27	27	32	14	1/2	M 22 x 1.5
NEGE 18L-04GE	18	32	27	27	31.5	14	1/2	M 26 x 1.5	
PN 160	NEGE 22L-06GE	22	36	32	32	32.5	16	3/4	M 30 x 1.5
	NEGE 28L-08GE	28	41	41	40	35	18	1	M 36 x 1.5
	NEGE 35L-10GE	35	50	50	50	42.5	20	1-1/4	M 45 x 2
	NEGE 42L-12GE	42	60	55	55	46.5	22	1-1/2	M 52 x 2
S light PN 315	NEGE 06S-02GE	6	17	19	19	27	12	1/4	M 14 x 1.5
	NEGE 08S-02GE	8	19	19	19	29.5	12	1/4	M 16 x 1.5
	NEGE 10S-03GE	10	22	22	22	35	12	3/8	M 18 x 1.5
	NEGE 12S-03GE	12	24	22	27	34	12	3/8	M 20 x 1.5
	NEGE 14S-04GE	14	27	27	27	36.5	14	1/4	M 22 x 1.5
PN 400	NEGE 16S-04GE	16	30	27	27	37	14	1/2	M 24 x 1.5
	NEGE 20S-06GE	20	36	32	32	43	16	3/4	M 30 x 2
	NEGE 25S-08GE	25	46	41	40	48	18	1	M 36 x 2
	NEGE 30S-10GE	30	50	50	50	51	20	1-1/4	M 42 x 2
PN 315	NEGE 38S-12GE	38	60	55	55	60	22	1-1/2	M 52 x 2

for Metric Parallel

Series	Part No.	Tube O.D D	H ₁	h	K	L	ℓ	T M(Metric)	T ₁
L light PN 315	NEGE 06L-10M10E	6	14	14	14	24.5	8	M 10 x 1	M 12 x 1.5
	NEGE 08L-12M15E	8	17	19	17	26.5	12	M 12 x 1.5	M 14 x 1.5
	NEGE 10L-14M15E	10	19	19	19	27.5	12	M 14 x 1.5	M 16 x 1.5
	NEGE 12L-16M15E	12	22	22	22	30.5	12	M 16 x 1.5	M 18 x 1.5
	NEGE 15L-18M15E	15	27	24	24	31.5	14	M 18 x 1.5	M 22 x 1.5
NEGE 18L-22M15E	18	32	27	27	31.5	14	M 22 x 1.5	M 26 x 1.5	
PN 160	NEGE 22L-26M15E	22	36	32	32	32.5	16	M 26 x 1.5	M 30 x 1.5
	NEGE 28L-33M20E	28	41	41	40	35	18	M 33 x 2	M 36 x 1.5
	NEGE 35L-42M20E	35	50	50	50	42.5	20	M 42 x 2	M 45 x 2
	NEGE 42L-48M20E	42	60	55	55	46.5	22	M 48 x 2	M 52 x 2
S light PN 315	NEGE 06S-12M15E	6	17	17	17	27	12	M 12 x 1.5	M 14 x 1.5
	NEGE 08S-14M15E	8	19	19	19	29.5	12	M 14 x 1.5	M 16 x 1.5
	NEGE 10S-16M15E	10	22	22	22	32	12	M 16 x 1.5	M 18 x 1.5
	NEGE 12S-18M15E	12	24	24	24	34	12	M 18 x 1.5	M 20 x 1.5
	NEGE 14S-20M15E	14	27	27	26	36.5	14	M 20 x 1.5	M 22 x 1.5
PN 400	NEGE 16S-22M15E	16	30	27	27	37	14	M 22 x 1.5	M 24 x 1.5
	NEGE 20S-27M20E	20	36	32	32	43	16	M 27 x 2	M 30 x 2
	NEGE 25S-33M20E	25	46	41	40	48	18	M 33 x 2	M 36 x 2
	NEGE 30S-42M20E	30	50	50	50	51	20	M 42 x 2	M 42 x 2
PN 315	NEGE 38S-48M20E	38	60	55	55	60	22	M 48 x 2	M 52 x 2

All dimensions given approx. figure with tighten nut. All dimensions are in millimeters.
Please see final assembly on page 10.

Swivel Union with Cone

NUE

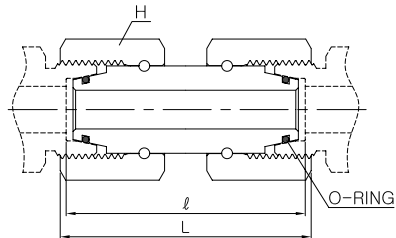

* O-ring of NBR standard, of FPM on request

Series	Part No.	Tube O.D	H ₁	L	ℓ
L light PN 500	NUE-06L	6	17	36	34
	NUE-08L	8	17	36	34
	NUE-10L	10	19	37	36
PB 400	NUE-12L	12	22	37	36
	NUE-15L	15	27	40	39
	NUE-18L	18	32	42.5	40.5
PB 250	NUE-22L	22	36	47	45
	NUE-28L	28	46	49	47
	NUE-35L	35	50	58	53
	NUE-42L	42	60	59	53
S light PN 315	NUE-06S	6	17	39	37
	NUE-08S	8	19	39	37
	NUE-10S	10	22	43	41
PN 630	NUE-12S	12	24	44	43
	NUE-14S	14	27	48	45
	NUE-16S	16	30	50	46
PN 400	NUE-20S	20	36	60	55
	NUE-25S	25	46	66	58
	NUE-30S	30	50	73	62
	NUE-38S	38	60	83	67

All dimensions given approx. figure with tighten nut. All dimensions are in millimeters.
Please see final assembly on page 10.

Welding Connector
NAS

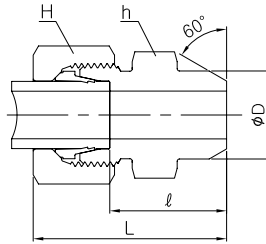

Series	Part No.	Tube O.D	D	H	h	L	l
L light PB 315	NAS-06L	6	10	14	12	29	14
	NAS-08L	8	12	17	14	31	16
	NAS-10L	10	14	19	17	33	18
	NAS-12L	12	16	22	19	33	18
	NAS-15L	15	19	27	22	37	22
PB 160	NAS-18L	18	22	32	27	40	23.5
	NAS-22L	22	27	32	32	45	28.5
	NAS-28L	28	32	41	41	47	30.5
	NAS-35L	35	40	50	46	54	32.5
S heavy PB 360	NAS-42L	42	46	60	55	58	35
	NGMA 3-06S	6	11	17	14	34	19
	NGMA 3-08S	8	13	19	17	36	21
	NGMA 3-10S	10	15	22	19	39	22.5
	NGMA 3-12S	12	17	24	22	41	24.5
PB 400	NGMA 3-14S	14	19	27	24	45	27
	NGMA 3-16S	16	21	30	27	45	26.5
	NGMA 3-20S	20	26	36	32	51	29.5
	NGMA 3-25S	25	31	46	41	56	32
PB 315	NGMA 3-30S	30	36	5	46	62	35.5
	NGMA 3-38S	38	44	60	55	69	38

All dimensions given approx. figure with tighten nut. All dimensions are in millimeters.

Welding Connector
with NC
NASK

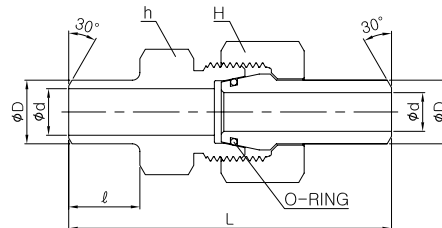

* O-ring of NBR standard, of FPM on request

Series	Part No.	Tube O.D	D	H	h	L	l
PB 248	NASK 10 x 1.0	10	8	22	19	58	10
PB 357	NASK 10 x 1.5	10	7	22	19	58	10
PB 458	NASK 10 x 2.0	10	6	22	19	58	10
PB 303	NASK 12 x 1.5	12	9	24	22	65	15
PB 391	NASK 12 x 2.0	12	8	24	22	65	15
PB 474	NASK 12 x 2.5	12	7	24	22	65	15
PB 234	NASK 16 x 1.5	16	13	30	27	74.5	16.5
PB 303	NASK 16 x 2.0	16	12	30	27	74.5	16.5
PB 370	NASK 16 x 2.5	16	11	30	27	74.5	16.5
PB 433	NASK 16 x 3.0	16	10	30	27	74.5	16.5
PB 249	NASK 20 x 1.5	20	16	36	32	84	19
PB 305	NASK 20 x 2.5	20	15	36	32	84	19
PB 357	NASK 20 x 3.0	20	14	36	32	84	19
PB 458	NASK 20 x 4.0	20	12	36	32	84	19
PB 292	NASK 25 x 3.0	25	19	46	41	94.5	19.5
PB 348	NASK 25 x 4.0	25	17	46	41	94.5	19.5
PB 458	NASK 25 x 5.0	25	15	46	41	94.5	19.5
PB 248	NASK 30 x 3.0	30	24	50	46	102	23
PB 321	NASK 30 x 4.0	30	22	50	46	102	23
PB 391	NASK 30 x 5.0	30	20	50	46	102	23
PB 460	NASK 30 x 6.0	30	18	50	46	102	23
PB 260	NASK 38 x 4.0	38	30	60	55	111	23
PB 318	NASK 38 x 5.0	38	28	60	55	111	23
PB 373	NASK 38 x 6.0	38	26	60	55	111	23
PB 427	NASK 38 x 7.0	38	24	60	55	111	23

All dimensions given approx. figure with tighten nut. All dimensions are in millimeters.

DK DIN Bite Type Tube Fitting

Welding Nipple with *O-Ring NC

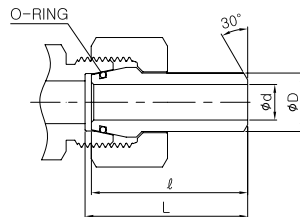

* O-ring of NBR standard, of FPM on request

Fittings	Series		Part No.	Tube O.D D	d	L	ℓ
	NAK and Tube						
PN 630	PB 248	NC 10 x 1.0	10	8	35.5	33	
	PB 357	NC 10 x 1.5	10	7	35.5	33	
	PB 458	NC 10 x 2.0	10	6	35.5	33	
PN 630	PB 303	NC 12 x 1.5	12	9	35.5	33	
	PB 391	NC 12 x 2.0	12	8	35.5	33	
	PB 474	NC 12 x 2.5	12	7	35.5	33	
PN 400	PB 234	NC 16 x 1.5	16	13	42.5	39	
	PB 303	NC 16 x 2.0	16	12	42.5	39	
	PB 370	NC 16 x 2.5	16	11	42.5	39	
	PB 433	NC 16 x 3.0	16	10	42.5	39	
PN 400	PB 249	NC 20 x 2.0	20	16	47.5	43.5	
	PB 305	NC 20 x 2.5	20	15	47.5	43.5	
	PB 357	NC 20 x 3.0	20	14	47.5	43.5	
	PB 458	NC 20 x 4.0	20	12	47.5	43.5	
PN 400	PB 292	NC 25 x 3.0	25	19	55	49.5	
	PB 348	NC 25 x 4.0	25	17	55	49.5	
	PB 458	NC 25 x 5.0	25	15	55	49.5	
PN 400	PB 248	NC 30 x 3.0	30	24	58.5	51.5	
	PB 321	NC 30 x 4.0	30	22	58.5	51.5	
	PB 391	NC 30 x 5.0	30	20	58.5	51.5	
	PB 460	NC 30 x 6.0	30	18	58.5	51.5	
PN 315	PB 260	NC 38 x 4.0	38	30	66	56.5	
	PB 318	NC 38 x 5.0	38	28	66	56.5	
	PB 373	NC 38 x 6.0	38	26	66	56.5	
	PB 427	NC 38 x 7.0	38	24	66	56.5	

All dimensions given approx. figure with tighten nut. All dimensions are in millimeters.

Reducing Welding Nipple with *O-Ring NCR

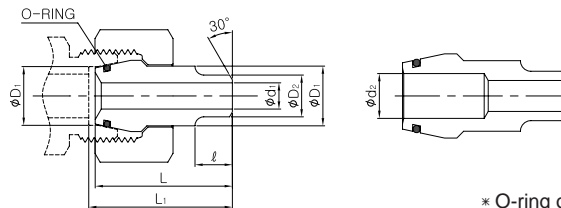

* O-ring of NBR standard, of FPM on request

Fittings	Series		Part No.	Tube O.D		d ₁	d ₂	L ₁	L	ℓ
	NAKR and Tube			D ₁	D ₂					
PN 630	PB 526	NCR 1006 x 1.5	10	6	3	5	37.5	35	12	
	PB 526	NCR 1008 x 2.0	10	8	4	-	37.5	35	12	
	PB 526	NCR 1208 x 2.0	12	8	4	6	37.5	35	14	
	PB 357	NCR 1210 x 1.5	12	10	7	-	37.5	35	14	
PN 400	PB 474	NCR 1612 x 2.5	16	12	7	-	46.5	43	15	
	PB 474	NCR 2012 x 2.5	20	12	7	-	51.5	47.5	15	
	PB 433	NCR 2016 x 3.0	20	16	10	-	53.5	49.5	17	
	PB 433	NCR 2516 x 3.0	25	16	10	-	56.5	51	17	
	PB 458	NCR 2520 x 4.0	25	20	12	-	59.5	54	20	
	PB 303	NCR 3016 x 2.0	30	16	12	-	67	60	17	
	PB 303	NCR 3020 x 2.5	30	20	15	-	70	63	20	
	PB 292	NCR 3025 x 3.0	30	25	19	-	70	63	20	
	PB 303	NCR 3816 x 2.0	38	16	12	-	79	69.5	17	
PN 400	PB 303	NCR 3820 x 2.5	38	20	15	-	82	72.5	20	
	PB 292	NCR 3825 x 3.0	38	25	19	-	82	72.5	20	
	PB 321	NCR 3830 x 4.0	38	30	22	-	82	72.5	20	

All dimensions given approx. figure with tighten nut. All dimensions are in millimeters.

Technical & Instruction for Welding Nipple

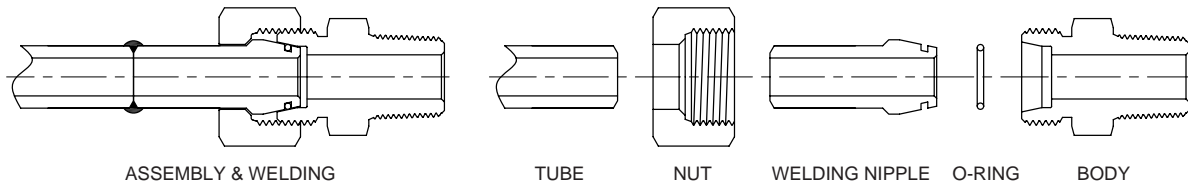

1. Cut the tube at right angle.
2. Deburr tube end at the inside and outside.
3. Place the nut on the welding nipple, as shown.
Welding nipple and tube according to the applicable guide lines for welding.
4. De-scale the weld and clean the o-ring groove.
5. Place the supplied o-ring into the body groove. O-ring must not be twisted.
6. Tighten nut by hand. The nut has to be tightened by 1/3 turn from hand tight with spanner.

Various Welding Nipple Assembly

Part No.	NGV NU (WITHOUT SLEEVE) + NAK	NWV NL (WITHOUT SLEEVE) + NAK	NTV NT (WITHOUT SLEEVE) + NAK
FIGURE			
Part No.	NWSEV NSWVE (WITHOUT SLEEVE) + NAK	NGEV-N/R NMC-N/R (WITHOUT SLEEVE) + NAK	NGEV-G/M NMC-G/M (WITHOUT SLEEVE) + NAK
FIGURE			
Part No.	NGUV NMC-GE/ME (WITHOUT SLEEVE) + NAK	NWEV-R/M NLM-RM (WITHOUT SLEEVE) + NAK	NGM-G/M NFC-G/M (WITHOUT SLEEVE) + NAK
FIGURE			

DK DIN Bite Type Tube Fitting

Adjustable Elbow with Standpipe NLA

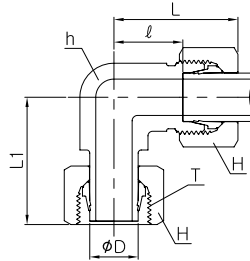

Series	Part No.	Tube O.D D	H	h	L	L ₁	l	T
L light PN 315	NLA-06L	6	14	12	27	26	12	M 12 x 1.5
	NLA-08L	8	17	12	29	27.5	14	M 14 x 1.5
	NLA-10L	10	19	14	30	29	15	M 16 x 1.5
	NLA-12L	12	22	17	32	29.5	17	M 18 x 1.5
	NLA-15L	15	27	19	36	32.5	21	M 22 x 1.5
PN 160	NLA-18L	18	32	24	40	35.5	23.5	M 26 x 1.5
	NLA-22L	22	36	27	44	38.5	27.5	M 30 x 2
	NLA-28L	28	41	36	47	41.5	30.5	M 36 x 2
	NLA-35L	35	50	41	56	51	34.5	M 45 x 2
S heavy PN 630	NLA-42L	42	60	50	63	56	40	M 52 x 2
	NLA-06S	6	17	12	31	27	16	M 14 x 1.5
	NLA-08S	8	19	14	32	27.5	17	M 16 x 1.5
	NLA-10S	10	22	17	34	30	17.5	M 18 x 1.5
	NLA-12S	12	24	17	38	31	21.5	M 20 x 1.5
PN 400	NLA-14S	14	27	19	40	35	22	M 22 x 1.5
	NLA-16S	16	30	24	43	36.5	24.5	M 24 x 1.5
	NLA-20S	20	36	27	48	44.5	26.5	M 30 x 2
	NLA-25S	25	46	36	54	50	30	M 36 x 2
PN 315	NLA-30S	30	50	41	62	55	35.5	M 42 x 2
	NLA-38S	38	60	50	72	63	41	M 52 x 2

All dimensions given approx. figure with tighten nut. All dimensions are in millimeters.
Tube stud have to swage for nut and cutting ring. Please see final assembly on page 10.
Nut and cutting ring are not supplied.

Adjustable Branch Tee with Standpipe NBTA

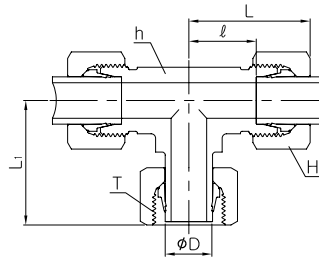

Series	Part No.	Tube O.D D	H	h	L	L ₁	l	T
L light PN 315	NBTA-06L	6	14	12	27	26	12	M 12 x 1.5
	NBTA-08L	8	17	12	29	27.5	14	M 14 x 1.5
	NBTA-10L	10	19	14	30	29	15	M 16 x 1.5
	NBTA-12L	12	22	17	32	29.5	17	M 18 x 1.5
	NBTA-15L	15	27	19	36	32.5	21	M 22 x 1.5
PN 160	NBTA-18L	18	32	24	40	35.5	23.5	M 26 x 1.5
	NBTA-22L	22	36	27	44	38.5	27.5	M 30 x 2
	NBTA-28L	28	41	36	47	41.5	30.5	M 36 x 2
	NBTA-35L	35	50	41	56	51	34.5	M 45 x 2
S heavy PN 630	NBTA-42L	42	60	50	63	56	40	M 52 x 2
	NBTA-06S	6	17	12	31	27	16	M 14 x 1.5
	NBTA-08S	8	19	14	32	27.5	17	M 16 x 1.5
	NBTA-10S	10	22	17	34	30	17.5	M 18 x 1.5
	NBTA-12S	12	24	17	38	31	21.5	M 20 x 1.5
PN 400	NBTA-14S	14	27	19	40	35	22	M 22 x 1.5
	NBTA-16S	16	30	24	43	36.5	24.5	M 24 x 1.5
	NBTA-20S	20	36	27	48	44.5	26.5	M 30 x 2
	NBTA-25S	25	46	36	54	50	30	M 36 x 2
PN 315	NBTA-30S	30	50	41	62	55	35.5	M 42 x 2
	NBTA-38S	38	60	50	72	63	41	M 52 x 2

All dimensions given approx. figure with tighten nut. All dimensions are in millimeters.
Tube stud have to swage for nut and cutting ring. Please see final assembly on page 10.
Nut and cutting ring are not supplied.

Adjustable Run Tee with Standpipe NRTA

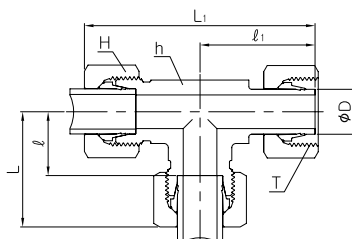

Series	Part No.	Tube O.D D	h	H	L	L ₁	ℓ	ℓ ₁	T
L light PN 315	NRTA-06L	6	12	14	27	53	12	26	M 12 x 1.5
	NRTA-08L	8	12	17	29	56	14	27.5	M 14 x 1.5
	NRTA-10L	10	14	19	30	59	15	29	M 16 x 1.5
	NRTA-12L	12	17	22	32	62	17	29.5	M 18 x 1.5
	NRTA-15L	15	19	27	36	69	21	32.5	M 22 x 1.5
PN 160	NRTA-18L	18	24	32	40	75	23.5	35.5	M 26 x 1.5
	NRTA-22L	22	27	36	44	83	27.5	38.5	M 30 x 2
	NRTA-28L	28	36	41	47	91	30.5	41.5	M 36 x 2
	NRTA-35L	35	41	50	56	111	34.5	51	M 45 x 2
S heavy PN 630	NRTA-42L	42	50	60	63	123	40	56	M 52 x 2
	NRTA-06S	6	12	17	31	58	16	27	M 14 x 1.5
	NRTA-08S	8	14	19	32	61	17	27.5	M 16 x 1.5
	NRTA-10S	10	17	22	34	66	17.5	30	M 18 x 1.5
	NRTA-12S	12	17	24	38	71	21.5	31	M 20 x 1.5
PN 400	NRTA-14S	14	19	27	40	75	22	35	M 22 x 1.5
	NRTA-16S	16	24	30	43	79	24.5	36.5	M 24 x 1.5
	NRTA-20S	20	27	36	48	93	26.5	44.5	M 30 x 2
	NRTA-25S	25	36	46	54	105	30	50	M 36 x 2
PN 315	NRTA-30S	30	41	50	62	119	35.5	55	M 42 x 2
	NRTA-38S	38	50	60	72	138	41	63	M 52 x 2

All dimensions given approx. figure with tighten nut. All dimensions are in millimeters.
Tube stud have to swage for nut and cutting ring. Please see final assembly on page 10.
Nut and cutting ring are not supplied.

Swivel Adjustable Elbow with Cone NEW

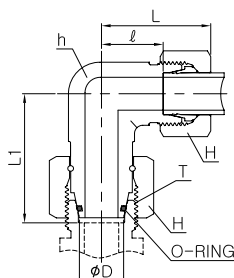

* O-ring of NBR standard, of FPM on request

Series	Part No.	Tube O.D D	H	h	L	ℓ	ℓ ₁	T
L light PN 315	NEW-06L	6	14	12	27	12	26	M 12 x 1.5
	NEW-08L	8	17	12	29	14	27.5	M 14 x 1.5
	NEW-10L	10	19	14	30	15	29	M 16 x 1.5
	NEW-12L	12	22	17	32	17	29.5	M 18 x 1.5
	NEW-15L	15	27	19	36	21	32.5	M 22 x 1.5
PN 160	NEW-18L	18	32	24	40	23.5	35.5	M 26 x 1.5
	NEW-22L	22	36	27	44	27.5	38.5	M 30 x 2
	NEW-28L	28	41	36	47	30.5	41.5	M 36 x 2
	NEW-35L	35	50	41	56	34.5	51	M 45 x 2
S heavy PN 630	NEW-42L	42	60	50	63	40	56	M 52 x 2
	NEW-06S	6	17	12	31	16	27	M 14 x 1.5
	NEW-08S	8	19	14	32	17	27.5	M 16 x 1.5
	NEW-10S	10	22	17	34	17.5	30	M 18 x 1.5
	NEW-12S	12	24	17	38	21.5	31	M 20 x 1.5
PN 400	NEW-14S	14	27	19	40	22	35	M 22 x 1.5
	NEW-16S	16	30	24	43	24.5	36.5	M 24 x 1.5
	NEW-20S	20	36	27	48	26.5	44.5	M 30 x 2
	NEW-25S	25	36	36	54	30	50	M 36 x 2
PN 315	NEW-30S	30	50	41	62	35.5	55	M 42 x 2
	NEW-38S	38	60	50	72	41	63	M 52 x 2

All dimensions given approx. figure with tighten nut. All dimensions are in millimeters.
Please see final assembly on page 10.

DK DIN Bite Type Tube Fitting

Swivel Adjustable Branch Tee with Cone

NET

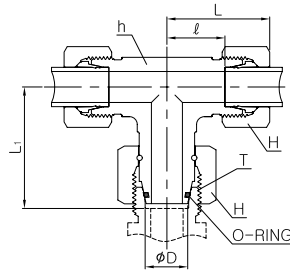

* O-ring of NBR standard, of FPM on request

Series	Part No.	Tube O.D D	H	h	L	L ₁	l	T
L light PN 315	NET-06L	6	14	12	27	26	12	M 12 x 1.5
	NET-08L	8	17	12	29	27.5	14	M 14 x 1.5
	NET-10L	10	19	14	30	29	15	M 16 x 1.5
	NET-12L	12	22	17	32	29.5	17	M 18 x 1.5
	NET-15L	15	27	19	36	32.5	21	M 22 x 1.5
PN 160	NET-18L	18	32	24	40	35.5	23.5	M 26 x 1.5
	NET-22L	22	36	27	44	38.5	27.5	M 30 x 2
	NET-28L	28	41	36	47	41.5	30.5	M 36 x 2
	NET-35L	35	50	41	56	51	34.5	M 45 x 2
S heavy PN 630	NET-42L	42	60	50	63	56	40	M 52 x 2
	NET-06S	6	17	12	31	27	16	M 14 x 1.5
	NET-08S	8	19	14	32	27.5	17	M 16 x 1.5
	NET-10S	10	22	17	34	30	17.5	M 18 x 1.5
PN 400	NET-12S	12	24	17	38	31	21.5	M 20 x 1.5
	NET-14S	14	27	19	40	35	22	M 22 x 1.5
	NET-16S	16	30	24	43	36.5	24.5	M 24 x 1.5
	NET-20S	20	36	27	48	44.5	26.5	M 30 x 2
PN 315	NET-25S	25	46	36	54	50	30	M 36 x 2
	NET-30S	30	50	41	62	55	35.5	M 42 x 2
	NET-38S	38	60	50	72	63	41	M 52 x 2

All dimensions given approx. figure with tighten nut. All dimensions are in millimeters.
Please see final assembly on page 10.

Swivel Adjustable Run Tee with Cone

NEL

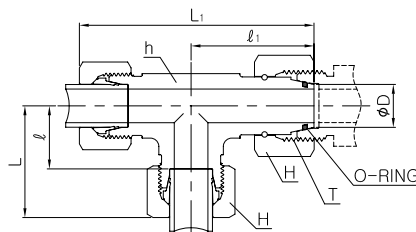

* O-ring of NBR standard, of FPM on request

Series	Part No.	Tube O.D D	H	h	L	L ₁	l	l ₁	T
L light PN 315	NEL-06L	6	14	12	27	53	12	26	M 12 x 1.5
	NEL-08L	8	17	12	29	56	14	27.5	M 14 x 1.5
	NEL-10L	10	19	14	30	59	15	29	M 16 x 1.5
	NEL-12L	12	22	17	32	61	17	29.5	M 18 x 1.5
	NEL-15L	15	27	19	36	69	21	32.5	M 22 x 1.5
PN 160	NEL-18L	18	32	24	40	75	23.5	35.5	M 26 x 1.5
	NEL-22L	22	36	27	44	82	27.5	38.5	M 30 x 2
	NEL-28L	28	41	36	47	89	30.5	41.5	M 36 x 2
	NEL-35L	35	50	41	56	107	34.5	51	M 45 x 2
S heavy PN 630	NEL-42L	42	60	50	63	119	40	56	M 52 x 2
	NEL-06S	6	17	12	31	58	16	27	M 14 x 1.5
	NEL-08S	8	19	14	32	59	17	27.5	M 16 x 1.5
	NEL-10S	10	22	17	34	64	17.5	30	M 18 x 1.5
PN 400	NEL-12S	12	24	17	38	69	21.5	31	M 20 x 1.5
	NEL-14S	14	27	19	40	75	22	35	M 22 x 1.5
	NEL-16S	16	30	24	43	79	24.5	36.5	M 24 x 1.5
	NEL-20S	20	36	27	48	93	26.5	44.5	M 30 x 2
PN 315	NEL-25S	25	46	36	54	104	30	50	M 36 x 2
	NEL-30S	30	50	41	62	117	35.5	55	M 42 x 2
	NEL-38S	38	60	50	72	135	41	63	M 52 x 2

All dimensions given approx. figure with tighten nut. All dimensions are in millimeters.
Please see final assembly on page 10.

Standpipe Reducer NKOR

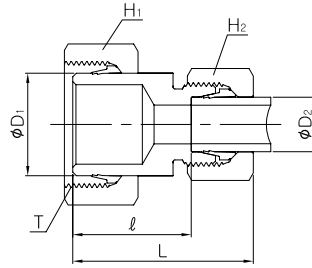

Series L

Series	Part No.	Tube O.D		H ₁	H ₂	L	ℓ	T
		D ₁	D ₂					
PN 315	NKOR 08L-06L	8	6	17	14	38	23.5	M14 x 1.5
PN 315	NKOR 10L-06L	10	6	19	14	38	23.5	M16 x 1.5
	NKOR 10L-08L	10	8	19	17	38	23.5	M16 x 1.5
PN 315	NKOR 12L-06L	12	6	22	14	38	23.5	M18 x 1.5
	NKOR 12L-08L	12	8	22	17	38	23.5	M18 x 1.5
PN 315	NKOR 12L-10L	12	10	22	19	39	24.5	M18 x 1.5
PN 315	NKOR 15L-06L	15	6	27	14	38	23.5	M22 x 1.5
	NKOR 15L-08L	15	8	27	17	38	23.5	M22 x 1.5
PN 315	NKOR 15L-10L	15	10	27	19	39	24.5	M22 x 1.5
	NKOR 15L-12L	15	12	27	22	39	24.5	M22 x 1.5
PN 315	NKOR 18L-06L	18	6	32	14	39	25.4	M26 x 1.5
	NKOR 18L-08L	18	8	32	17	39	24.5	M26 x 1.5
	NKOR 18L-10L	18	10	32	19	40	25.5	M26 x 1.5
	NKOR 18L-12L	18	12	32	22	40	25.5	M26 x 1.5
PN 160	NKOR 18L-15L	18	15	32	27	42	26.5	M26 x 1.5
	NKOR 22L-06L	22	6	36	14	40	25.5	M30 x 2
	NKOR 22L-08L	22	8	36	17	40	25.5	M30 x 2
	NKOR 22L-10L	22	10	36	19	41	26.5	M30 x 2
PN 160	NKOR 22L-12L	22	12	36	22	41	26.5	M30 x 2
	NKOR 22L-15L	22	15	36	27	43	27.5	M30 x 2
	NKOR 22L-18L	22	18	36	32	43	27	M30 x 2
	PN 160	NKOR 28L-06L	28	6	41	14	41	26.5
NKOR 28L-08L		28	8	41	17	41	26.5	M36 x 2
NKOR 28L-10L		28	10	41	19	42	27.5	M36 x 2
NKOR 28L-12L		28	12	41	22	42	27.5	M36 x 2
NKOR 28L-15L		28	15	41	27	44	28.5	M36 x 2
NKOR 28L-18L		28	18	41	32	44	28	M36 x 2
PN 160	NKOR 28L-22L	28	22	41	36	46	30	M36 x 2
	NKOR 35L-06L	35	6	50	14	46	31.5	M45 x 2
	NKOR 35L-08L	35	8	50	17	46	31.5	M45 x 2
	NKOR 35L-10L	35	10	50	19	47	32.5	M45 x 2
	NKOR 35L-12L	35	12	50	22	47	32.5	M45 x 2
	NKOR 35L-15L	35	15	50	27	49	33.5	M45 x 2
PN 160	NKOR 35L-18L	35	18	50	32	49	33	M45 x 2
	NKOR 35L-22L	35	22	50	36	51	35	M45 x 2
	NKOR 35L-28L	35	28	50	41	52	35	M45 x 2
	NKOR 42L-10L	42	10	60	19	48	33.5	M52 x 2
	NKOR 42L-12L	42	12	60	22	48	33.5	M52 x 2
	NKOR 42L-15L	42	15	60	27	50	34.5	M52 x 2
PN 160	NKOR 42L-18L	42	18	60	32	50	34	M52 x 2
	NKOR 42L-22L	42	22	60	36	52	36	M52 x 2
	NKOR 42L-28L	42	28	60	41	53	36	M52 x 2
	NKOR 42L-35L	42	35	60	50	57	35	M52 x 2

Series S

Series	Part No.	Tube O.D		H ₁	H ₂	L	ℓ	T	
		D ₁	D ₂						
PN 630	NKOR 08S-06S	8	6	19	17	40	25	M16 x 1.5	
PN 630	NKOR 10S-06S	10	6	22	17	41	26	M18 x 1.5	
	NKOR 10S-08S	10	8	22	19	41	26	M18 x 1.5	
PN 630	NKOR 12S-06S	12	6	24	17	42	27	M20 x 1.5	
	NKOR 12S-08S	12	8	24	19	42	27	M20 x 1.5	
	NKOR 12S-10S	12	10	24	22	43	26.5	M20 x 1.5	
PN 630	NKOR 14S-06S	14	6	27	17	44	29	M22 x 1.5	
	NKOR 14S-08S	14	8	27	19	44	29	M22 x 1.5	
	NKOR 14S-10S	14	10	27	22	45	28.5	M22 x 1.5	
	NKOR 14S-12S	14	12	27	24	45	28.5	M22 x 1.5	
PN 400	NKOR 16S-06S	16	6	30	17	44	29	M24 x 1.5	
	NKOR 16S-08S	16	8	30	19	44	29	M24 x 1.5	
	NKOR 16S-10S	16	10	30	22	45	28.5	M24 x 1.5	
	NKOR 16S-12S	16	12	30	24	45	28.5	M24 x 1.5	
PN 400	NKOR 16S-14S	16	14	30	27	48	30	M24 x 1.5	
	NKOR 20S-06S	20	6	36	17	49	34	M30 x 2	
	NKOR 20S-08S	20	8	36	19	49	34	M30 x 2	
	NKOR 20S-10S	20	10	36	22	50	33.5	M30 x 2	
PN 400	NKOR 20S-12S	20	12	36	24	50	33.5	M30 x 2	
	NKOR 20S-14S	20	14	36	27	53	35	M30 x 2	
	NKOR 20S-16S	20	16	36	30	53	34.5	M30 x 2	
	PN 400	NKOR 25S-06S	25	6	46	17	52	37	M36 x 2
NKOR 25S-08S		25	8	46	19	52	37	M36 x 2	
NKOR 25S-10S		25	10	46	22	53	36.5	M36 x 2	
NKOR 25S-12S		25	12	46	24	53	36.5	M36 x 2	
NKOR 25S-14S		25	14	46	27	55	37	M36 x 2	
NKOR 25S-16S		25	16	46	30	55	36.5	M36 x 2	
PN 400	NKOR 25S-20S	25	20	46	36	59	37.5	M36 x 2	
	NKOR 30S-06S	30	6	50	17	54	39	M42 x 2	
	NKOR 30S-08S	30	8	50	19	54	39	M42 x 2	
	NKOR 30S-10S	30	10	50	22	55	38.5	M42 x 2	
	NKOR 30S-12S	30	12	50	24	55	38.5	M42 x 2	
	NKOR 30S-14S	30	14	50	27	58	40	M42 x 2	
PN 400	NKOR 30S-16S	30	16	50	30	58	39.5	M42 x 2	
	NKOR 30S-20S	30	20	50	36	61	39.5	M42 x 2	
	NKOR 30S-25S	30	25	50	46	64	40	M42 x 2	
	PN 315	NKOR 38S-06S	38	6	60	17	58	43	M52 x 2
		NKOR 38S-08S	38	8	60	19	58	43	M52 x 2
		NKOR 38S-10S	38	10	60	22	59	42.5	M52 x 2
NKOR 38S-12S		38	12	60	24	59	42.5	M52 x 2	
NKOR 38S-14S		38	14	60	27	62	44	M52 x 2	
NKOR 38S-16S		38	16	60	30	62	43.5	M52 x 2	
PN 315	NKOR 38S-20S	38	20	60	36	65	43.5	M52 x 2	
	NKOR 38S-25S	38	25	60	46	68	44	M52 x 2	
	NKOR 38S-30S	38	30	60	50	71	44.5	M52 x 2	

All dimensions given approx. figure with tighten nut. All dimensions are in millimeters.
 Tube stud have to swage for nut and cutting ring. Please see final assembly on page 10.
 Nut and cutting ring are not supplied.

DK DIN Bite Type Tube Fitting

Reducer NR

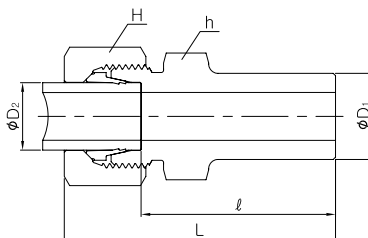

Series L

Series	Part No.	Tube O.D		H	h	L	l
		D ₁	D ₂				
L	NR 08L-06L	8	6	14	12	40	25.5
	NR 10L-06L	10	6	14	12	42	27.5
	NR 10L-08L	10	8	17	14	43	27.5
	NR 12L-06L	12	6	14	14	42	27.5
	NR 12L-08L	12	8	17	14	43	27.5
	NR 12L-10L	12	10	19	17	44	28.5
	NR 15L-06L	15	6	14	19	44	29
	NR 15L-08L	15	8	17	19	44	29
	NR 15L-10L	15	10	19	19	45	30
	NR 15L-12L	15	12	22	19	45	30
	NR 18L-06L	18	6	14	19	46	31
	NR 18L-08L	18	8	17	19	46	31
	NR 18L-10L	18	10	19	19	47	32
	NR 18L-12L	18	12	22	19	47	32
NR 18L-15L	18	15	27	22	49	33	
PN160	NR 22L-06L	22	6	14	24	48	33
	NR 22L-08L	22	8	17	24	48	33
	NR 22L-10L	22	10	19	24	49	34
	NR 22L-12L	22	12	22	24	49	34
	NR 22L-15L	22	15	27	24	50	35
	NR 22L-18L	22	18	32	27	51	34.5
	NR 28L-06L	28	6	14	30	48	33
	NR 28L-08L	28	8	17	30	48	33
	NR 28L-10L	28	10	19	30	49	34
	NR 28L-12L	28	12	22	30	49	34
	NR 28L-15L	28	15	27	30	50	35
	NR 28L-18L	28	18	32	30	51	36
	NR 28L-22L	28	22	36	32	53	36.5
	NR 35L-06L	35	6	14	36	53	38.5
	NR 35L-08L	35	8	17	36	53	38.5
	NR 35L-10L	35	10	19	36	55	39.5
	NR 35L-12L	35	12	22	36	55	39.5
	NR 35L-15L	35	15	27	36	56	40.5
	NR 35L-18L	35	18	32	36	56	40
	NR 35L-22L	35	22	36	36	58	42
	NR 35L-28L	35	28	41	36	59	42
	NR 42L-06L	42	6	14	46	56	41
	NR 42L-08L	42	8	17	46	56	41
	NR 42L-10L	42	10	19	46	58	42
	NR 42L-12L	42	12	22	46	58	42
	NR 42L-15L	42	15	27	46	60	43
	NR 42L-18L	42	18	32	46	60	42.5
	NR 42L-22L	42	22	36	46	62	44.5
	NR 42L-28L	42	28	41	46	64	44.5
	NR 42L-35L	42	35	50	46	67	43.5

Series S

Series	Part No.	Tube O.D		H	h	L	l
		D ₁	D ₂				
PN 630	NR 08S-06S	8	6	17	14	43	28
	NR 10S-06S	10	6	17	14	45	30.5
	NR 10S-08S	10	8	19	17	45	30.5
	NR 12S-06S	12	6	17	14	47	32.5
	NR 12S-08S	12	8	19	17	47	32.5
	NR 12S-10S	12	10	22	19	48	32
	NR 14S-06S	14	6	17	17	51	36.5
	NR 14S-08S	14	8	19	17	51	36.5
	NR 14S-10S	14	10	22	19	52	36
	NR 14S-12S	14	12	24	22	52	36
	NR 16S-06S	16	6	17	17	53	38.5
	NR 16S-08S	16	8	19	17	53	38.5
	NR 16S-10S	16	10	22	19	54	38
	NR 16S-12S	16	12	24	22	55	38.5
NR 16S-14S	16	14	27	22	57	39.5	
PN 400	NR 20S-06S	20	6	17	22	58	43
	NR 20S-08S	20	8	19	22	58	43
	NR 20S-10S	20	10	22	22	59	42.5
	NR 20S-12S	20	12	24	22	59	42.5
	NR 20S-14S	20	14	27	22	62	44
	NR 20S-16S	20	16	30	24	62	43.5
	NR 25S-06S	25	6	17	27	62	47.5
	NR 25S-08S	25	8	19	27	62	47.5
	NR 25S-10S	25	10	22	27	63	47
	NR 25S-12S	25	12	24	27	63	47
	NR 25S-14S	25	14	27	27	66	48.5
	NR 25S-16S	25	16	30	27	66	48
	NR 25S-20S	25	20	36	30	70	48
	NR 30S-06S	30	6	17	32	67	52
	NR 30S-08S	30	8	19	32	67	52
	NR 30S-10S	30	10	22	32	68	51.5
	NR 30S-12S	30	12	24	32	68	51.5
	NR 30S-14S	30	14	27	32	71	53
	NR 30S-16S	30	16	30	32	71	52.5
	NR 30S-20S	30	20	36	32	74	52.5
NR 30S-25S	30	25	46	36	77	53	
PN 315	NR 38S-06S	38	6	17	41	72	57
	NR 38S-08S	38	8	19	41	72	57
	NR 38S-10S	38	10	22	41	73	56.5
	NR 38S-12S	38	12	24	41	73	56.5
	NR 38S-14S	38	14	27	41	76	58
	NR 38S-16S	38	16	30	41	76	57.5
	NR 38S-20S	38	20	36	41	79	57.5
	NR 38S-25S	38	25	46	41	82	58
	NR 38S-30S	38	30	50	46	89	58.5

All dimensions given approx. figure with tighten nut. All dimensions are in millimeters.

Swivel Reducing Adapter
with Cone
NRED

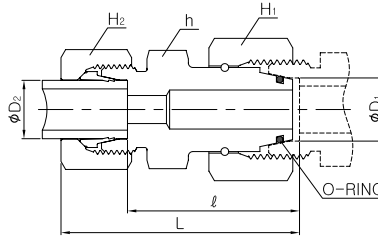

* O-ring of NBR standard, of FPM on request

Series L

Series	Part No.	Tube O.D		H ₁	H ₂	h	L	ℓ
		D ₁	D ₂					
PN 315	NRED 08L-06L	8	6	17	14	14	39	24.5
PN 315	NRED 10L-06L	10	6	19	14	17	39.5	24.5
	NRED 10L-08L	10	8	19	17	17	39.5	24.5
PN 315	NRED 12L-06L	12	6	22	14	17	40	25
	NRED 12L-08L	12	8	22	17	17	40	25
	NRED 12L-10L	12	10	22	19	17	41	26
PN 315	NRED 15L-06L	15	6	27	14	22	42	27.5
	NRED 15L-08L	15	8	27	17	22	42	27.5
	NRED 15L-10L	15	10	27	19	22	43	28.5
	NRED 15L-12L	15	12	27	22	22	43	28.5
PN 315	NRED 18L-06L	18	6	32	14	25	43	28
	NRED 18L-08L	18	8	32	17	25	43	28
	NRED 18L-10L	18	10	32	19	25	44.5	29.5
	NRED 18L-12L	18	12	32	22	25	44.5	29.5
	NRED 18L-15L	18	15	32	27	25	45.5	30.5
PN 160	NRED 22L-06L	22	6	36	14	28.5	47	32
	NRED 22L-08L	22	8	36	17	28.5	47	32
	NRED 22L-10L	22	10	36	19	28.5	48	33
	NRED 22L-12L	22	12	36	22	28.5	48	33
	NRED 22L-15L	22	15	36	27	28.5	49	34
	NRED 22L-18L	22	18	36	32	28.5	50	33.5
PN 160	NRED 28L-06L	28	6	41	14	36	49	34
	NRED 28L-08L	28	8	41	17	36	49	34
	NRED 28L-10L	28	10	41	19	36	50	35
	NRED 28L-12L	28	12	41	22	36	50	35
	NRED 28L-15L	28	15	41	27	36	51	36
	NRED 28L-18L	28	18	41	32	36	52	35.5
	NRED 28L-22L	28	22	41	36	36	54	37.5
PN 160	NRED 35L-06L	35	6	50	14	46	55	40
	NRED 35L-08L	35	8	50	17	46	55	40
	NRED 35L-10L	35	10	50	19	46	56	41
	NRED 35L-12L	35	12	50	22	46	56	41
	NRED 35L-15L	35	15	50	27	46	57	42
	NRED 35L-18L	35	18	50	32	46	58	41.5
	NRED 35L-22L	35	22	50	36	46	60	43.5
	NRED 35L-28L	35	28	50	41	46	60	43.5
PN 160	NRED 42L-06L	42	6	60	14	50	55	40.5
	NRED 42L-08L	42	8	60	17	50	55	40.5
	NRED 42L-10L	42	10	60	19	50	56	41.5
	NRED 42L-12L	42	12	60	22	50	56	41.5
	NRED 42L-15L	42	15	60	27	50	58	42.5
	NRED 42L-18L	42	18	60	32	50	58	45
	NRED 42L-22L	42	22	60	36	50	60	44
	NRED 42L-28L	42	28	60	41	50	61	44
	NRED 42L-35L	42	35	60	50	50	65	43

Series S

Series	Part No.	Tube O.D		H ₁	H ₂	h	L	ℓ
		D ₁	D ₂					
PN 630	NRED 08S-06S	8	6	19	17	17	44	28
PN 630	NRED 10S-06S	10	6	22	17	17	44	29.5
	NRED 10S-08S	10	8	22	19	17	44	29.5
PN 630	NRED 12S-06S	12	6	24	17	19	45	30
	NRED 12S-08S	12	8	24	19	19	45	30
	NRED 12S-10S	12	10	24	22	19	46	29.5
PN 630	NRED 14S-06S	14	6	37	17	22	47.5	33
	NRED 14S-08S	14	8	37	19	22	47.5	33
	NRED 14S-10S	14	10	37	22	22	48.5	32.5
	NRED 14S-12S	14	12	37	24	22	48.5	32.5
PN 630	NRED 16S-06S	16	6	30	17	24	50	35
	NRED 16S-08S	16	8	30	19	24	50	35
	NRED 16S-10S	16	10	30	22	24	51	34.5
	NRED 16S-12S	16	12	30	24	24	51	34.5
	NRED 16S-14S	16	14	30	27	24	54	36
PN 400	NRED 20S-06S	20	6	36	17	28.5	54	39
	NRED 20S-08S	20	8	36	19	28.5	54	39
	NRED 20S-10S	20	10	36	22	28.5	55	38.5
	NRED 20S-12S	20	12	36	24	28.5	55	38.5
	NRED 20S-14S	20	14	36	27	28.5	58	40
	NRED 20S-16S	20	16	36	30	28.5	58	39.5
PN 400	NRED 25S-06S	25	6	46	17	36	58	43.5
	NRED 25S-08S	25	8	46	19	36	58	43.5
	NRED 25S-10S	25	10	46	22	36	59	43
	NRED 25S-12S	25	12	46	24	36	59	43
	NRED 25S-14S	25	14	46	27	36	62	44.5
	NRED 25S-16S	25	16	46	30	36	62	44
	NRED 25S-20S	25	20	46	36	36	66	44
PN 400	NRED 30S-06S	30	6	50	17	41	66	51
	NRED 30S-08S	30	8	50	19	41	66	51
	NRED 30S-10S	30	10	50	22	41	67	50.5
	NRED 30S-12S	30	12	50	24	41	67	50.5
	NRED 30S-14S	30	14	50	27	41	70	52
	NRED 30S-16S	30	16	50	30	41	70	51.5
	NRED 30S-20S	30	20	50	36	41	73	51.5
	NRED 30S-25S	30	25	50	46	41	76	52
PN 400	NRED 38S-06S	38	6	60	17	50	70.5	56
	NRED 38S-08S	38	8	60	19	50	70.5	56
	NRED 38S-10S	38	10	60	22	50	71.5	55.5
	NRED 38S-12S	38	12	60	24	50	71.5	55.5
	NRED 38S-14S	38	14	60	27	50	74.5	57
	NRED 38S-16S	38	16	60	30	50	74.5	56.5
	NRED 38S-20S	38	20	60	36	50	78.5	56.5
	NRED 38S-25S	38	25	60	46	50	81.5	57
	NRED 38S-30S	38	30	60	50	50	85.5	58.5

All dimensions given approx. figure with tighten nut. All dimensions are in millimeters.
Please see final assembly on page 10.

DK DIN Bite Type Tube Fitting

Banjo Fittings
(BSP Parallel / Metric Parallel)

NSLM-G/M

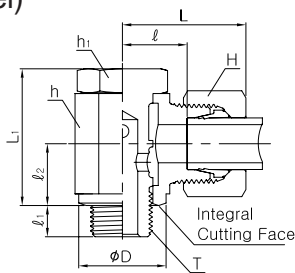

For tube O.D up to 15mm

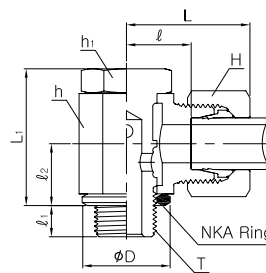

For tube O.D 16mm and larger

for BSP Parallel

Series	Part No.	Tube O.D	D	H	h	h ₁	L	L ₁	l	l ₁	l ₂	T G(PF)	*MA
L light PN 315	NSLM 06L-01G	6	14.5	14	14	14	25	21	10.5	6	10	1/8	20
	NSLM 08L-02G	8	18.5	17	19	19	28	27	13	9	13	1/4	45
	NSLM 10L-02G	10	18.5	19	19	19	29	27	14	9	13	1/4	45
	NSLM 12L-03G	12	22.5	22	22	22	30	32	15.5	9	15	3/8	70
PB 160	NSLM 15L-04G	15	26.5	27	27	27	34	37.5	19	11	18	1/2	100
	NSLM 18L-04G	18	26	32	30	27	37	44	20.5	11	21.5	1/2	100
NSLM 22L-06G	NSLM 22L-06G	22	32	36	36	32	42	49	25.5	13	24	3/4	140
	NSLM 06S-02G	6	18.5	17	19	19	30	27	15	9	13	1/4	45
S heavy PB 250	NSLM 08S-02G	8	18.5	19	19	19	30	27	15	9	13	1/4	45
	NSLM 10S-03G	10	22.5	22	22	22	32	32	16	9	15	3/8	70
	NSLM 12S-03G	12	22.5	24	24	24	33	37	17	9	18	3/8	70
	NSLM 14S-04G	14	26.5	27	27	27	38	37	20	11	18	1/4	100
PN 400	NSLM 16S-04G	16	26	30	30	27	40	44	21.5	11	21.5	1/2	100
	NSLM 20S-06G	20	32	36	36	32	46	49	24.5	13	24	3/4	140

for Metric Parallel

Series	Part No.	Tube O.D	D	H	h	h ₁	L	L ₁	l	l ₁	l ₂	T M(Metric)	*MA
L light PB 250	NSLM 06L-10M10	6	14.5	14	14	14	25	21.5	10.5	6	10	M 10 x 1	25
	NSLM 08L-12M15	8	17.5	17	17	17	27	25	12	9	12	M 12 x 1.5	40
	NSLM 10L-14M15	10	19.5	19	19	19	29	27	14	9	13	M 14 x 1.5	55
	NSLM 12L-16M15	12	21.5	22	22	22	30	32	15.5	9	15	M 16 x 1.5	65
PB 160	NSLM 15L-18M15	15	23.5	27	27	27	33	37.5	17.5	9	18	M 18 x 1.5	90
	NSLM 18L-22M15	18	27	32	30	27	37	44	20.5	11	21.5	M 22 x 1.5	130
NSLM 22L-26M15	22	31	36	36	32	42	49	25.5	13	24	M 26 x 1.5	140	
S heavy PB 250	NSLM 06S-12M15	6	17.5	17	17	17	29	25	14	9	12	M 12 x 1.5	40
	NSLM 08S-14M15	8	19.5	19	19	19	30	27	15	9	13	M 14 x 1.5	55
	NSLM 10S-16M15	10	21.5	22	22	22	32	32	16	9	15	M 16 x 1.5	65
	NSLM 12S-18M15	12	23.5	24	24	24	33	37	17	9	18	M 18 x 1.5	90
PB 160ar	NSLM 14S-20M15	14	25.5	27	27	27	38	37	20	11	18	M 20 x 1.5	120
	NSLM 16S-22M15	16	27	30	30	27	40	44	21.5	11	21.5	M 22 x 1.5	130
NSLM 20S-27M20	20	32	36	36	32	46	49	24.5	13	24	M 27 x 2	150	

All dimensions given approx. figure with tighten nut. All dimensions are in millimeters.

*MA is recommended tightening torque(Nm) for male G and M

High Pressure Banjo Fittings
(BSP Parallel / Metric Parallel)

NWH-G/M

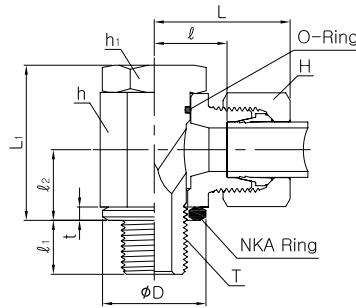

* O-ring of NBR standard, of FPM on request

for BSP Parallel

Series	Part No.	Tube O.D	D	H	h	h ₁	L	L ₁	l	l ₁	l ₂	t	T G(PF)	*MA
L light PB 315	NWH 06L-01G	6	14	14	17	17	27	24	12	8	10.5	2.5	1/8	20
	NWH 08L-02G	8	18	17	22	19	29	30	14.5	12	14	3	1/4	50
	NWH 10L-02G	10	18	19	22	19	30	30	15.5	12	14	3	1/4	50
	NWH 12L-03G	12	22	22	27	24	33	36	18	12	16.5	3	3/8	75
	NWH 15L-04G	15	26	27	32	30	37	45	21.5	14	21.5	4.5	1/2	130
PB 160	NWH 18L-04G	18	26	32	32	30	37	45	21	14	21.5	4.5	1/2	130
	NWH 22L-06G	22	32	36	41	36	44	53	27.5	16	24	3.5	3/4	250
	NWH 28L-08G	28	39	41	50	46	49	66	32	18	30.5	3.5	1	350
	NWH 35L-10G	35	49	50	60	55	58	76	36	20	35.5	3.5	1-1/4	600
S heavy PB 400	NWH 42L-12G	42	55	60	70	60	63	87	40.5	22	40.5	3.5	1-1/2	800
	NWH 06S-02G	6	18	17	22	19	31	30	16.5	12	14	3	1/4	50
	NWH 08S-02G	8	18	19	22	19	31	30	16.5	12	14	3	1/4	50
PB 250	NWH 10S-03G	10	22	22	27	24	35	36	18.5	12	16.5	3	3/8	75
	NWH 12S-03G	12	22	24	27	24	35	36	18.5	12	16.5	3	3/8	75
	NWH 16S-04G	16	26	30	32	30	40	45	22	14	21.5	4.5	1/2	130
	NWH 20S-06G	20	32	36	41	36	48	53	26.5	16	24	3.5	3/4	250
	NWH 25S-08G	25	39	46	50	46	56	66	31.5	18	30.5	3.5	1	350
PB 250	NWH 30S-10G	30	49	50	60	55	64	76	37	20	34.5	3.5	1-1/4	600
	NWH 38S-12G	38	55	60	70	60	72	87	41.5	22	40.5	3.5	1-1/2	800

for Metric Parallel

Series	Part No.	Tube O.D	D	H	h	h ₁	L	L ₁	l	l ₁	l ₂	t	T M(Metric)	*MA
L light PB 315	NWH 06L-10M10	6	14	14	17	17	27	24	12	8	10.5	2.5	M 10 x 1	25
	NWH 06L-12M15	8	17	17	22	19	29	30	14.5	12	14	3	M 12 x 1.5	50
	NWH 10L-14M15	10	19	19	22	19	30	30	15.5	12	14	3	M 14 x 1.5	60
	NWH 12L-16M15	12	21	22	27	24	33	36	18	12	16.5	3	M 16 x 1.5	90
	NWH 15L-18M15	15	23	27	30	27	36	39.5	20.5	12	18.5	3	M 18 x 1.5	110
PB 160	NWH 18L-22M15	18	27	32	32	30	37	45	21	14	21.5	4.5	M 22 x 1.5	150
	NWH 22L-26M15	22	31	36	41	36	44	53	27.5	16	24	3.5	M 26 x 1.5	350
	NWH 28L-33M20	28	39	41	50	46	49	66	32	18	30.5	3.5	M 33 x 2	400
	NWH 35L-42M20	35	49	50	60	55	58	76	36	20	35.5	3.5	M 42 x 2	600
L heavy PB 400	NWH 42L-48M20	42	55	60	70	60	63	87	40.5	22	40.5	3.5	M 48 x 2	800
	NWH 06S-12M15	6	17	17	22	19	31	30	16.5	12	14	3	M 12 x 1.5	50
	NWH 08S-14M15	8	19	19	22	19	31	30	16.5	12	14	3	M 14 x 1.5	60
	NWH 10S-16M15	10	21	22	27	24	35	36	18.5	12	16.5	3	M 16 x 1.5	90
	NWH 12S-18M16	12	23	24	30	27	36	39.5	20	12	18.5	3	M 18 x 1.5	110
PB 250	NWH 16S-22M15	16	27	30	32	30	40	45	22	14	21.5	4.5	M 22 x 1.5	150
	NWH 20S-27M20	20	32	36	41	36	48	53	26.5	16	24	3.5	M 27 x 2	350
	NWH 25S-33M20	25	39	46	50	46	56	66	31.5	18	30.5	3.5	M 33 x 2	400
	NWH 30S-42M20	30	49	50	60	55	64	76	37	20	35.5	3.5	M 42 x 2	600
PB 250	NWH 38S-48M20	38	55	60	70	60	72	87	41.5	22	40.5	3.5	M 48 x 2	800

All dimensions given approx. figure with tighten nut. All dimensions are in millimeters.

*MA is recommended tightening torque(Nm) for male G and M

High Pressure Banjo Fittings (BSP Parallel / Metric Parallel)

NTH-G/M

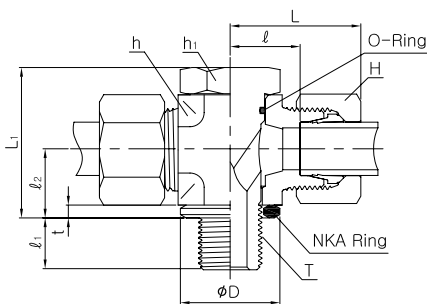

* O-ring of NBR standard, of FPM on request

for BSP Parallel

Series	Part No.	Tube O.D	D	H	h	h ₁	L	L ₁	l	l ₁	l ₂	t	T G(PF)	*MA
L light PB 315	NTH 06L-01G	6	14	14	17	17	27	24	12	8	10.5	2.5	1/8	20
	NTH 08L-02G	8	18	17	22	19	29	30	14.5	12	14	3	1/4	50
	NTH 10L-02G	10	18	19	22	19	30	30	15.5	12	14	3	1/4	50
	NTH 12L-03G	12	22	22	27	24	33	36	18	12	16.5	3	3/8	75
	NTH 15L-04G	15	26	27	32	30	37	45	21.5	12	21.5	4.5	1/2	130
PB 160	NTH 18L-04G	18	26	32	32	30	37	45	21	14	21.5	4.5	1/2	130
	NTH 22L-06G	22	32	36	41	36	44	53	27.5	16	24	3.5	3/4	250
	NTH 28L-08G	28	39	41	50	46	49	66	32	18	30.5	3.5	1	350
	NTH 35L-10G	35	49	50	60	55	58	76	36	20	35.5	3.5	1-1/4	600
S heavy PB 400	NTH 42L-12G	42	55	60	70	60	63	87	40.5	22	40.5	3.5	1-1/2	800
	NTH 06S-02G	6	18	17	22	19	31	30	16.5	12	14	3	1/4	50
	NTH 08S-02G	8	18	19	22	19	31	30	16.5	12	14	3	1/4	50
	NTH 10S-03G	10	22	22	27	24	35	36	18.5	12	16.5	3	3/8	75
	NTH 12S-03G	12	22	24	27	24	35	36	18.5	12	16.5	3	3/8	75
PB 250	NTH 16S-04G	16	26	30	32	30	40	45	22	14	21.5	4.5	1/2	130
	NTH 20S-06G	20	32	36	41	36	48	53	26.5	16	24	3.5	3/4	250
	NTH 25S-08G	25	39	46	50	46	56	66	31.5	18	30.5	3.5	1	350
	NTH 30S-10G	30	49	50	60	55	64	76	37	20	34.5	3.5	1-1/4	600
	NTH 38S-12G	38	55	60	70	60	72	87	41.5	22	40.5	3.5	1-1/2	800

for Metric Parallel

Series	Part No.	Tube O.D	D	H	h	h ₁	L	L ₁	l	l ₁	l ₂	t	T M(Metric)	*MA
L light PB 315	NTH 06L-10M10	6	14	14	17	17	27	24	12	8	10.5	2.5	M 10 x 1	25
	NTH 08L-12M15	8	17	17	22	19	29	30	14.5	12	14	3	M 12 x 1.5	50
	NTH 10L-14M15	10	19	19	22	19	30	30	15.5	12	14	3	M 14 x 1.5	60
	NTH 12L-16M15	12	21	22	27	24	33	36	18	12	16.5	3	M 16 x 1.5	90
	NTH 15L-18M15	15	23	27	30	27	36	39.5	20.5	12	18.5	3	M 18 x 1.5	110
PB 160	NTH 18L-22M15	18	27	32	32	30	37	45	21	14	21.5	4.5	M 22 x 1.5	150
	NTH 22L-26M15	22	31	36	41	36	44	53	27.5	16	24	3.5	M 26 x 1.5	350
	NTH 28L-33M20	28	39	41	50	46	49	66	35	18	30.5	3.5	M 33 x 2	400
	NTH 35L-42M20	35	49	50	60	55	58	76	36	20	35.5	3.5	M 42 x 2	600
L heavy PB 400	NTH 42L-48M20	42	55	60	70	60	63	87	40.5	22	40.5	3.5	M 48 x 2	800
	NTH 06S-12M15	6	17	17	22	19	31	30	16.5	12	14	3	M 12 x 1.5	50
	NTH 08S-14M15	8	19	19	22	19	31	30	16.5	12	14	3	M 14 x 1.5	60
	NTH 10S-16M15	10	21	22	27	24	35	36	18.5	12	16.5	3	M 16 x 1.5	90
	NTH 12S-18M15	12	23	24	30	27	36	39.5	20	12	18.5	3	M 18 x 1.5	110
PB 250	NTH 16S-22M15	16	27	30	32	30	40	45	22	14	21.5	4.5	M 22 x 1.5	150
	NTH 20S-27M20	20	32	36	41	36	48	53	26.5	16	24	3.5	M 27 x 2	350
	NTH 25S-33M20	25	39	46	50	46	56	66	31.5	18	30.5	3.5	M 33 x 2	400
	NTH 30S-42M20	30	49	50	60	55	64	76	37	20	35.5	3.5	M 42 x 2	600
	NTH 38S-48M20	38	55	60	70	60	72	87	41.5	22	40.5	3.5	M 48 x 2	800

All dimensions given approx. figure with tighten nut. All dimensions are in millimeters.

*MA is recommended tightening torque(Nm) for male G and M

Throttle-Free Banjo Fittings (BSP Parallel / Metric Parallel)

NSVW-G/M

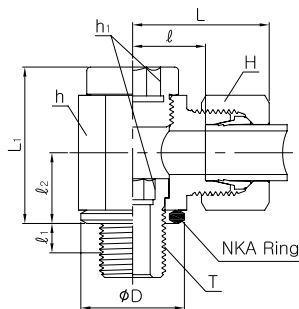

for BSP Parallel

Series	Part No.	Tube O.D	D	H	h	h ₁	L	L ₁	l	l ₁	l ₂	T G(PF)
L light PB 250	NSVW 06L-01G	6	14	14	19	6	27	24	12.5	8	12	1/8
	NSVW 08L-02G	8	18	17	22	8	29	30	14.5	12	16	1/4
	NSVW 10L-02G	10	18	19	22	8	30	30	15.5	12	16	1/4
	NSVW 12L-03G	12	22	22	27	10	33	37	18	12	18	3/8
PB 100	NSVW 15L-04G	15	26	27	32	12	37	42	22	14	21	1/2
	NSVW 18L-04G	18	26	32	36	12	37	46	21.5	14	23	1/2
	NSVW 22L-06G	22	32	36	46	17	45	58	28.5	16	28	3/4
	NSVW 28L-08G	28	39	41	50	22	48	64	31.5	18	32	1
S light PB 400	NSVW 35L-10G	35	49	50	60	27	57	76	35.5	20	37	1-1/4
	NSVW 42L-12G	42	55	60	65	32	63	85	40	22	42	1-1/2
	NSVW 06S-02G	6	18	17	22	8	31	30	16.5	12	16	1/4
	NSVW 08S-02G	8	18	19	22	8	31	30	16.5	12	16	1/4
PB 250	NSVW 10S-03G	10	22	22	27	10	35	37	18.5	12	18	3/8
	NSVW 12S-03G	12	22	24	27	10	35	37	18.5	12	18	3/8
	NSVW 14S-04G	14	26	27	32	12	41	42	23	14	21	1/2
	NSVW 16S-04G	16	26	30	36	12	41	46	22.5	14	23	1/2
PB 250	NSVW 20S-06G	20	32	36	46	17	49	58	27.5	16	28	3/4
	NSVW 25S-08G	25	39	46	50	22	55	64	31.5	18	32	1
	NSVW 30S-10G	30	49	50	60	27	63	76	36.5	20	37	1-1/4
	NSVW 38S-12G	38	55	60	70	32	72	85	41	22	42	1-1/2

for Metric Parallel

Series	Part No.	Tube O.D	D	H	h	h ₁	L	L ₁	l	l ₁	l ₂	T M(Metric)
L light PB 250	NSVW 06L-10M10	6	14	14	19	6	27	24	12.5	8	12	M 10 x 1
	NSVW 08L-12M15	8	17	17	22	6	29	30	14.5	12	15	M 12 x 1.5
	NSVW 10L-14M15	10	19	19	22	8	30	30	15.5	12	16	M 14 x 1.5
	NSVW 12L-16M15	12	21	22	27	10	33	37	18	12	18	M 16 x 1.5
	NSVW 15L-18M15	15	23	27	30	12	36	40	21	12	20	M 18 x 1.5
PB 100	NSVW 18L-22M15	18	27	32	36	14	38	46	21.5	14	23	M 22 x 1.5
	NSVW 22L-26M15	22	31	36	41	17	42	51	26	16	25	M 26 x 1.5
	NSVW 28L-33M20	28	39	41	50	22	48	64	31.5	18	32	M 33 x 2
	NSVW 35L-42M20	35	49	50	60	27	57	76	35.5	20	27	M 42 x 2
	NSVW 42L-48M20	42	55	60	65	32	63	85	40	22	42	M 48 x 2
L heavy PB 400	NSVW 06S-12M15	6	17	17	22	6	31	30	16.5	12	15	M 12 x 1.5
	NSVW 08S-14M15	8	19	19	22	8	31	30	16.5	12	16	M 14 x 1.5
	NSVW 10S-16M15	10	21	22	27	10	35	37	18.5	12	18	M 16 x 1.5
	NSVW 12S-18M15	12	23	24	30	12	37	41	20.5	12	20	M 18 x 1.5
	NSVW 14S-20M15	14	25	27	32	12	41	42	23	14	21	M 20 x 1.5
	NSVW 16S-22M15	16	27	30	36	14	41	46	22.5	14	23	M 22 x 1.5
	NSVW 20S-27M20	20	32	36	46	17	49	58	27.5	16	28	M 27 x 2
PB 250	NSVW 25S-33M20	25	39	46	50	22	55	64	31	18	32	M 33 x 2
	NSVW 30S-42M20	30	49	50	60	27	63	76	36.5	20	27	M 42 x 2
	NSVW 38S-48M20	38	55	60	70	32	72	85	41	22	42	M 48 x 2

All dimensions given approx. figure with tighten nut. All dimensions are in millimeters.

Throttle-Free Banjo Fittings (BSP Parallel / Metric Parallel)

NSVT-G/M

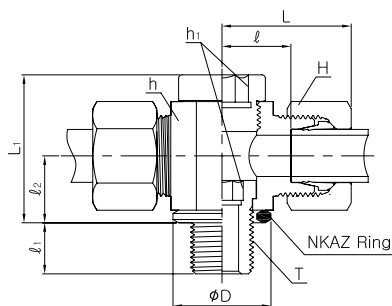

for BSP Parallel

Series	Part No.	Tube O.D	D	H	h	h ₁	L	L ₁	l	l ₁	l ₂	T G(PF)
L light PB 250	NSVT 06L-01G	6	14	14	18	6	27	24	12	8	12	1/8
	NSVT 08L-02G	8	18	17	22	8	29	30	14.7	12	15	1/4
	NSVT 10L-02G	10	18	19	22	8	30	30	15	12	15	1/4
	NSVT 12L-03G	12	22	22	27	10	32	36	17.5	12	18	3/8
PB 100	NSVT 15L-04G	15	26	27	30	12	35	40	20	14	20	1/2
	NSVT 18L-04G	18	26	32	30	12	36	40	19.5	14	20	1/2
	NSVT 22L-06G	22	32	36	41	17	43	52	27	16	25	3/4
	NSVT 28L-08G	28	39	41	46	22	46	58	29.5	18	29	1
S heavy PB 400	NSVT 35L-10G	35	49	50	55	27	55	69	33	20	34	1-1/4
	NSVT 42L-12G	42	55	60	65	32	63	84	40	22	41	1-1/2
	NSVT 06S-02G	6	18	17	22	8	31	30	16	12	15	1/4
	NSVT 08S-02G	8	18	19	22	8	31	30	16	12	15	1/4
PB 400	NSVT 10S-03G	10	22	22	27	10	34	36	18	12	18	3/8
	NSVT 12S-03G	12	22	24	27	10	34	36	18	12	18	3/8
	NSVT 14S-04G	14	26	27	32	12	40	42	22	14	21	1/2
	NSVT 16S-04G	16	26	30	32	12	40	42	21.5	14	21	1/2
PB 250	NSVT 20S-06G	20	32	36	46	17	50	57	28.5	16	28	3/4
	NSVT 25S-08G	25	39	46	50	22	55	62	31	18	31	1
	NSVT 30S-10G	30	49	50	60	27	63	74	36.5	20	36	1-1/4
	NSVT 38S-12G	38	55	60	70	32	72	84	41	22	41	1-1/2

for Metric Parallel

Series	Part No.	Tube O.D	D	H	h	h ₁	L	L ₁	l	l ₁	l ₂	T M(Metric)
L light PB 250	NSVT 06L-10M10	6	14	14	18	6	27	24	12	8	12	M 10 x 1
	NSVT 08L-12M15	8	17	17	20	6	28	27	13	12	14	M 12 x 1.5
	NSVT 10L-14M15	10	19	19	22	8	30	30	15	12	15	M 14 x 1.5
	NSVT 12L-16M15	12	21	22	27	10	32	36	17.5	12	18	M 16 x 1.5
	NSVT 15L-18M15	15	23	27	30	12	35	39	20	12	19	M 18 x 1.5
PB 100	NSVT 18L-22M15	18	27	32	32	14	37	41	20.5	14	20	M 22 x 1.5
	NSVT 22L-26M15	22	31	36	36	17	41	46	24.5	16	22	M 26 x 1.5
	NSVT 28L-33M20	28	39	41	46	22	46	58	29.5	18	29	M 33 x 2
	NSVT 35L-42M20	35	49	50	55	27	58	69	33	20	33	M 42 x 2
	NSVT 42L-48M20	42	55	60	65	32	63	84	40	22	41	M 48 x 2
L heavy PB 400	NSVT 06S-12M15	6	17	17	20	6	30	27	15	12	14	M 12 x 1.5
	NSVT 08S-14M15	8	19	19	22	8	31	30	16	12	15	M 14 x 1.5
	NSVT 10S-16M15	10	21	22	27	10	34	36	18	12	18	M 16 x 1.5
	NSVT 12S-18M15	12	23	24	30	12	36	39	19.5	12	19	M 18 x 1.5
	NSVT 14S-20M15	14	25	27	32	12	40	41	22	14	20	M 20 x 1.5
	NSVT 16S-22M15	16	27	30	36	14	42	45	23.5	14	22	M 22 x 1.5
PB 250	NSVT 20S-27M20	20	32	36	46	17	50	58	28.5	16	28	M 27 x 2
	NSVT 25S-33M20	25	39	46	50	22	55	62	31	18	31	M 33 x 2
	NSVT 30S-42M20	30	49	50	60	27	63	74	36.5	20	36	M 42 x 2
	NSVT 38S48M20	38	55	60	70	32	72	84	41	22	41	M 48 x 2

All dimensions given approx. figure with tighten nut. All dimensions are in millimeters.

Pressure Gauge Connector
(BSP Parallel)

NGC-G

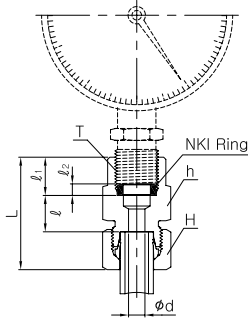

Series	Part No.	Tube O.D	d	H	h	L	ℓ	ℓ ₁	ℓ ₂	T G(PF)
L light PN 315	NGC 06L-02G	6	2.5	14	19	37	7.5	14.5	4.5	1/4
	NGC 08L-02G	8	5.5	17	19	37	7.5	14.5	4.5	1/4
	NGC 10L-02G	10	5.5	19	19	38	8.5	14.5	4.5	1/4
	NGC 12L-02G	12	5.5	22	19	38	8.5	14.5	4.5	1/4
S heavy PN 630	NGC 06S-04G	6	3.5	17	27	46	11	20	5	1/2
	NGC 08S-04G	8	3.5	19	27	46	11	20	5	1/2
	NGC 10S-04G	10	7	22	27	47	10.5	20	5	1/2
	NGC 12S-04G	12	7	24	27	47	10.5	20	5	1/2

All dimensions are in millimeters.

Swivel Gauge Connector
(BSP Parallel)

NGE-G

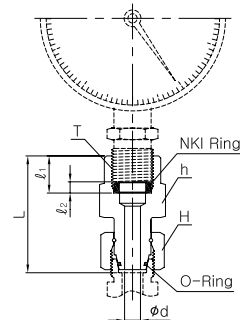

Series	Part No.	Tube O.D	d	H	h	L	ℓ ₁	ℓ ₂	T G(PF)
L light PN 315	NGE 06L-02G	6	2.5	14	19	35.5	14.5	4.5	1/4
	NGE 08L-02G	8	4	17	19	35.5	14.5	4.5	1/4
	NGE 10L-02G	10	5.5	19	19	36	14.5	4.5	1/4
	NGE 12L-02G	12	5.5	22	19	36	14.5	4.5	1/4
S heavy PN 630	NGE 06S-04G	6	2.5	17	27	42.5	20	5	1/2
	NGE 08S-04G	8	4	19	27	43	20	5	1/2
	NGE 10S-04G	10	6	22	27	43.5	20	5	1/2
	NGE 12S-04G	12	7	24	27	45	20	5	1/2
	NGE 06S-02G	6	2.5	17	19	35.5	14.5	4.5	1/4
	NGE 08S-02G	8	4	19	19	35.5	14.5	4.5	1/4
	NGE 10S-02G	10	6	22	19	36	14.5	4.5	1/4
	NGE 12S-02G	12	7	24	19	39	14.5	4.5	1/4

All dimensions are in millimeters.

Gauge Adaptor
(BSP Parallel)

NGA-G

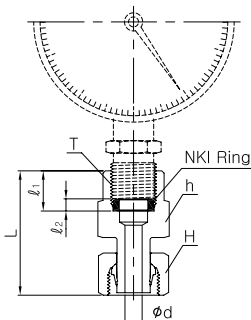

Series	Part No.	Tube O.D	d	H	h	L	ℓ ₁	ℓ ₂	T G(PF)
L light PN 315	NGA 06L-02G	6	6	14	19	38	14.5	4.5	1/4
	NGA 08L-02G	8	8	17	19	38	14.5	4.5	1/4
	NGA 10L-02G	10	10	19	19	39.5	14.5	4.5	1/4
	NGA 12L-02G	12	12	22	19	40.5	14.5	4.5	1/4
S heavy PN 630	NGA 06S-04G	6	6	17	27	45	20	5	1/2
	NGA 08S-04G	8	8	19	27	45	20	5	1/2
	NGA 10S-04G	10	10	22	27	47	20	5	1/2
	NGA 12S-04G	12	12	24	27	47.5	20	5	1/2

All dimensions are in millimeters.

Tee Test Coupling with Threaded Connection **NGMA**

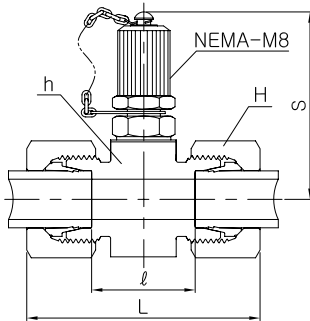

Series	Part No.	Tube O.D	H	h	L	l	S
L light PB 315	NGMA-06L	6	14	24	50	20.5	45
	NGMA-08L	8	17	24	50	20	45
	NGMA-10L	10	19	24	52	22.5	45
	NGMA-12L	12	22	24	52	22.5	45
	NGMA-15L	15	27	30	55	24.5	48
PB 160	NGMA-18L	18	32	32	56	23.5	49
	NGMA-22L	22	36	36	60	27.5	51
	NGMA-28L	28	41	41	61	27.5	53
	NGMA-35L	35	50	46	69	25.5	56
S heavy PB 360	NGMA-42L	42	60	55	70	24.5	60
	NGMA-06S	6	17	24	54	24.5	45
	NGMA-08S	8	19	24	5	24.5	45
	NGMA-10S	10	22	24	45	23.5	45
PB 400	NGMA-12S	12	24	24	6	23.5	45
	NGMA-14S	14	27	27	56	26.5	46
	NGMA-16S	16	30	30	62	25.5	48
	NGMA-20S	20	36	36	62	25.5	51
PB 315	NGMA-25S	25	46	41	69	26.5	53
	NGMA-30S	30	50	46	75	27.5	56
	NGMA-38S	38	60	55	81	29	60

All dimensions are in millimeters.

Test Coupling with Threaded Connection **NEMA**

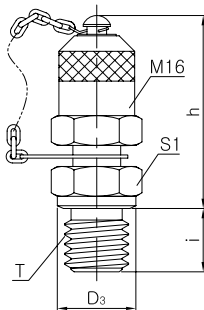

From "B" stud end standard
(From "E" stud end available)

Series	Part No.	D ₃	h	i	S ₁	T
PB 630	NEMA-01G	14	36	8	17	PF 1/8
	NEMA-02G	18	36	10	19	PF 1/4
	NEMA-03G	22	36	12	22	PF 3/8
	NEMA-04G	26	36	14	27	PF 1/2
PB 630	NEMA-10M10	14	36	8	17	M 10 x 1
	NEMA-12M15	17	36	12	17	M 12 x 1.5
	NEMA-14M15	19	36	12	19	M 14 x 1.5
	NEMA-16M15	21	36	12	22	M 16 x 1.5

All dimensions are in millimeters.

General Standard for Non-Return Valves

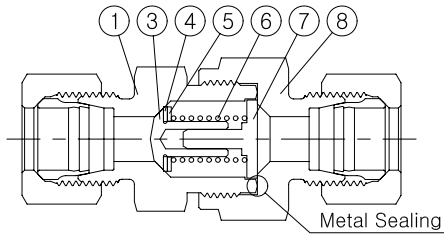

Material of Construction

No.	Description	Material	Q'ty
*1	Body	Carbon Steel	1
*2	Connector	Carbon Steel	1
*3	Poppet	Carbon Steel	1
†4	Seat	FKM	1
*5	Seat Support	Carbon Steel	1
6	Spring	Stainless Steel	1
*7	Stopper	Carbon Steel	1

* On request of stainless steel 316 or brass available

† On request of NBR or EPDM available

Feature

- Opening pressure: Standard setting is 14.5 psig (1 bar) and 7.3 to 43.5 psig (0.5 to 3 bar) available.
- Temperature range: -4 to 212°C (-20 to 100°C)
- Sealing is 90° tapered cone (item no.③).

Application

- Non Return valves are applicable with hydraulic fluid and compressed air.
- For other fluid contact for our sales department.

Non-Return Valves

NCVU

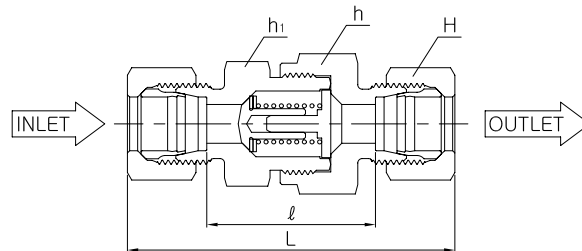

Series	Part No.	Tube O.D	H	h	h ₁	L	l
L light PB 250	NCVU-06L	6	14	17	17	58	29
	NCVU-08L	8	17	19	19	59	30
	NCVU-10L	10	19	24	22	69.5	40.5
	NCVU-12L	12	22	30	27	72.5	43.5
	NCVU-15L	15	27	32	27	77.5	47.5
PB 100	NCVU-18L	18	32	36	36	83.5	51.5
	NCVU-22L	22	36	46	41	93.5	61.5
	NCVU-28L	28	41	55	50	102.5	69.5
	NCVU-35L	35	50	60	60	117.5	74.5
	NCVU-42L	42	60	70	65	119	74
S heavy PB 400	NCVU-06S	6	17	19	19	63.5	34.5
	NCVU-08S	8	19	19	19	63.5	34.5
	NCVU-10S	10	22	24	22	72.5	40.5
	NCVU-12S	12	24	27	24	74.5	42.5
	NCVU-14S	14	27	32	27	82.5	47.5
	NCVU-16S	16	30	36	32	86.5	50.5
	NCVU-20S	20	36	46	41	97.5	54.5
PB 250	NCVU-25S	25	46	50	46	106.5	58.5
	NCVU-30S	30	50	60	60	122.5	69.5
	NCVU-38S	38	60	70	65	136.5	75.5

All dimensions given approx. figure with tighten nut. All dimensions are in millimeters.

DK DIN Bite Type Tube Fitting

Non-Return Valves

NCV GE-L/S NCV ME-L/S

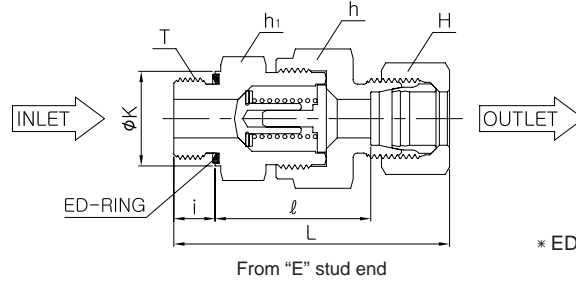

From "E" stud end

* ED-ring of NBR standard, of FPM on request

for BSP Parallel

Series	Part No.	Tube O.D	H	h	h ₁	K	L	ℓ	i	T G(PF)
L light PB 250	NCV01GE-06L	6	14	17	17	14	42.5	28	8	1/8
	NCV02GE-08L	8	17	19	19	19	44.5	30	12	1/4
	NCV02GE-10L	10	19	24	22	19	53	38.5	12	1/4
	NCV03GE-12L	12	22	30	27	22	57	42.5	12	3/8
PB 160	NCV04GE-15L	15	27	32	27	27	60.5	45.5	14	1/2
	NCV04GE-18L	18	32	36	36	27	66	50	14	1/2
PB 100	NCV06GE-22L	22	36	46	41	32	71	53	16	3/4
	NCV08GE-28L	28	41	55	50	40	79.5	63	18	1
	NCV10GE-35L	35	50	60	60	50	90.5	69	20	1-1/4
	NCV12GE-42L	42	60	70	65	55	91	68.5	22	1-1/2
S heavy PB 400	NCV02GE-06S	6	17	19	19	19	46	31.5	12	1/4
	NCV02GE-08S	8	19	19	19	19	46	31.5	12	1/4
	NCV03GE-10S	10	22	24	22	22	54	38	12	3/8
	NCV03GE-12S	12	24	27	24	22	57	41	12	3/8
	NCV04GE-14S	14	27	32	27	27	62	44.5	14	1/2
	NCV04GE-16S	16	30	36	32	27	66	48	14	1/2
PB 250	NCV06GE-20S	20	36	46	41	32	73.5	52	16	3/4
	NCV08GE-25S	25	46	50	46	40	78.5	54.5	18	1
	NCV10GE-30S	30	50	60	60	50	90.5	65	20	1-1/4
	NCV12GE-38S	38	60	70	65	55	100	69.5	22	1-1/2

for Metric Parallel

Series	Part No.	Tube O.D	H	h	h ₁	K	L	ℓ	i	T M(Metric)
L light PB 250	NCV10M10E-06L	6	14	17	17	14	42.5	28	8	M 10 x 1.0
	NCV12M15E-08L	8	17	19	19	17	43.5	30	12	M 12 x 1.5
	NCV14M15E-10L	10	19	24	22	19	53	38.5	12	M 14 x 1.5
	NCV16M15E-12L	12	22	30	27	22	57	42.5	12	M 16 x 1.5
	NCV18M15E-15L	15	27	32	27	24	60.5	45.5	12	M 18 x 1.5
PB 160	NCV22M15E-18L	18	32	36	36	27	66	50	14	M 22 x 1.5
	NCV26M15E-22L	22	36	46	41	32	71	53	16	M 26 x 1.5
PB 100	NCV33M20E-28L	28	41	55	50	40	79.5	63	18	M 33 x 2.0
	NCV42M20E-35L	35	50	60	60	50	90.5	69	20	M 42 x 2.0
	NCV48M20E-4L2	42	60	70	65	55	91	67.5	22	M 48 x 2.0
S heavy PB 400	NCV12M15E-06S	6	17	19	19	17	46	31.5	12	M 12 x 1.5
	NCV14M15E-08S	8	19	19	19	19	46	31.5	12	M 14 x 1.5
	NCV16M15E-10S	10	22	24	22	22	54	38	12	M 16 x 1.5
	NCV18M15E-12S	12	24	27	24	24	57	41	12	M 18 x 1.5
	NCV20M15E-14S	14	27	32	27	26	62	44.5	14	M 20 x 1.5
	NCV22M15E-16S	16	30	36	32	27	66	48	14	M 22 x 1.5
PB 250	NCV27M15E-20S	20	36	46	41	32	73.5	52	16	M 27 x 2.0
	NCV33M20E-25S	25	46	50	46	40	78.5	54.5	18	M 33 x 2.0
	NCV42M20E-30S	30	50	60	60	50	90.5	65	20	M 42 x 2.0
	NCV48M20E-38S	38	60	70	65	55	100	69.5	22	M 48 x 2.0

All dimensions given approx. figure with tighten nut. All dimensions are in millimeters.

Non-Return Valves

NCV L/S-GE

NCV L/S-ME

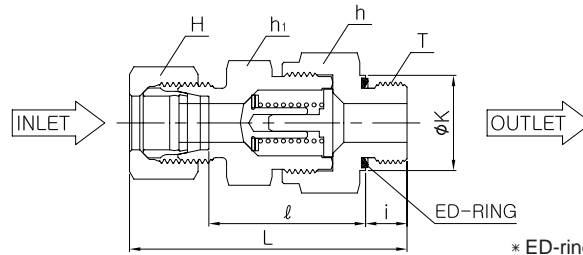

From "E" stud end

* ED-ring of NBR standard, of FPM on request

for BSP Parallel

Series	Part No.	Tube O.D	H	h	h ₁	K	L	ℓ	i	T G(PF)
L light PB 250	NCV06L-01GE	6	14	17	17	14	41	26.5	8	1/8
	NCV08L-02GE	8	17	19	19	19	13	28.5	12	1/4
	NCV10L-02GE	10	19	24	22	19	53	38.5	12	1/4
	NCV12L-03GE	12	22	30	27	22	55	40.5	12	3/8
PB 160	NCV15L-04GE	15	27	32	27	27	57.5	42.5	14	1/2
	NCV18L-04GE	18	32	36	36	27	64	48	14	1/2
PB 100	NCV22L-06GE	22	36	46	41	32	72	56	16	3/4
	NCV28L-08GE	28	41	55	50	40	80.5	64	18	1
	NCV35L-10GE	35	50	60	60	50	91.5	70	20	1-1/4
S heavy PB 400	NCV42L-12GE	42	60	70	65	55	93	70.5	22	1-1/2
	NCV06S-02GE	6	17	19	19	19	46	31.5	12	1/4
	NCV08S-02GE	8	19	19	19	19	46	31.5	12	1/4
	NCV10S-03GE	10	22	24	22	22	54	38	12	3/8
	NCV12S-03GE	12	24	27	24	22	57	41	12	3/8
	NCV14S-04GE	14	27	32	27	27	61	43.5	14	1/2
PB 250	NCV16S-04GE	16	30	36	32	27	64	46	14	1/2
	NCV20S-06GE	20	36	46	41	32	71.5	50	16	3/4
	NCV25S-08GE	25	46	50	46	40	78.5	54.5	18	1
	NCV30S-10GE	30	50	60	60	50	90.5	64	20	1-1/4
	NCV38S-12GE	38	60	70	65	55	102	71.5	22	1-1/2

for Metric Parallel

Series	Part No.	Tube O.D	H	h	h ₁	K	L	ℓ	i	T M(Metric)
L light PB 250	NCV06L-10M10E	6	14	17	17	14	41	26.5	8	M 10 x 1.0
	NCV08L-12M15E	8	17	19	19	17	43	28.5	12	M 12 x 1.5
	NCV10L-14M15E	10	19	24	22	19	53	38.5	12	M 14 x 1.5
	NCV12L-16M15E	12	22	30	27	22	55	40.5	12	M 16 x 1.5
	NCV15L-18M15E	15	27	32	27	24	57.5	42.5	12	M 18 x 1.5
PB 160	NCV18L-22M15E	18	32	36	36	27	64	48	14	M 22 x 1.5
	NCV22L-26M15E	22	36	46	41	32	72	56	16	M 26 x 1.5
PB 100	NCV28L-33M20E	28	41	55	50	40	80.5	64	18	M 33 x 2.0
	NCV35L-42M20E	35	50	60	60	50	91.5	70	20	M 42 x 2.0
	NCV42L-48M20E	42	60	70	65	55	93	70.5	22	M 48 x 2.0
S heavy PB 400	NCV06S-12M15E	6	17	19	19	17	46	31.5	12	M 12 x 1.5
	NCV08S-14M15E	8	19	19	19	19	46	31.5	12	M 14 x 1.5
	NCV10S-16M15E	10	22	24	22	22	54	38	12	M 16 x 1.5
	NCV12S-18M15E	12	24	27	24	24	57	41	12	M 18 x 1.5
	NCV14S-20M15E	14	27	32	27	26	61	43.5	14	M 20 x 1.5
	NCV16S-22M15E	16	30	36	32	27	64	46	14	M 22 x 1.5
PB 250	NCV20S-27M20E	20	36	46	41	32	71.5	50	16	M 27 x 2.0
	NCV25S-33M20E	25	46	50	46	40	78.5	54.5	18	M 33 x 2.0
	NCV30S-42M20E	30	50	60	60	50	90.5	65	20	M 42 x 2.0
	NCV38S-48M20E	38	60	70	65	55	102	71.5	22	M 48 x 2.0

All dimensions given approx. figure with tighten nut. All dimensions are in millimeters.

Male Female Adapter (BSP Parallel)

NHB

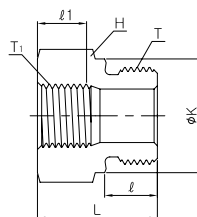

* DIN 3852 Form "B" stud end

PB	Part No.	H	K	L	l	l ₁	Male stud T G(PF)	Female stud T ₁ G(PF)
PB 630	NHB 03-01G	22	22	22.5	12	8	3/8	1/8
PB 630	NHB 04-01G	27	26	24	14	8	1/2	1/8
PB 400	NHB 04-02G	27	26	24	14	12	1/2	1/4
PB 400	NHB 06-02G	32	32	26	16	12	3/4	1/4
	NHB 06-03G	32	32	26	16	12	3/4	3/8
PB 400	NHB 08-02G	41	39	29	18	12	1	1/4
	NHB 08-03G	41	39	29	18	12	1	3/8
	NHB 08-04G	41	39	29	18	14	1	1/2
PB 250	NHB 10-04G	50	49	32	20	14	1 1/4	1/2
	NHB 10-06G	50	49	32	20	16	1 1/4	3/4
PB 250	NHB 12-04G	55	55	36	22	14	1 1/2	1/2
	NHB 12-06G	55	55	36	22	16	1 1/2	3/4
	NHB 12-08G	55	55	36	22	18	1 1/2	1

All dimensions are in millimeters.

Male Female Adapter (BSP Parallel)

NABMF

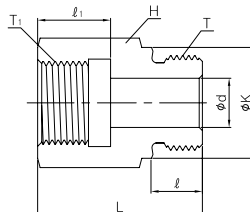

* DIN 3852 Form "B" stud end

PB	Part No.	d	H	K	L	l	l ₁	Male stud T G(PF)	Female stud T ₁ G(PF)
PB 630	NABMF 01-02G	4	19	14	31	8	17	1/8	1/4
	NABMF 01-03G	4	24	14	32	8	17	1/8	3/8
PB 630	NABMF 02-01G	5	19	18	28	12	12	1/4	1/8
	NABMF 02-03G	5	24	18	36	12	17	1/4	3/8
	NABMF 02-04G	5	30	18	40	12	20	1/4	1/2
PB 400	NABMF 02-06G	5	36	18	43	12	22	1/4	3/4
PB 630	NABMF 03-02G	8	22	22	36	12	17	3/8	1/4
	NABMF 03-04G	8	30	22	41	12	20	3/8	1/2
PB 250	NABMF 03-06G	8	36	22	44	12	22	3/8	3/4
PB 400	NABMF 04-03G	12	27	26	36	14	17	1/2	3/8
	NABMF 04-06G	12	36	26	46	14	22	1/2	3/4
	NABMF 04-08G	12	41	26	49	14	24.5	1/2	1
PB 250	NABMF 04-10G	10	55	26	53	14	26.5	1/2	1 1/4
PB 400	NABMF 06-04G	16	32	32	41	16	20	3/4	1/2
	NABMF 06-08G	16	41	32	51	16	24.5	3/4	1
	NABMF 06-10G	16	55	32	55	16	26.5	3/4	1 1/4
PB 250	NABMF 06-12G	16	60	32	57	16	28.5	3/4	1 1/2
PB 400	NABMF 08-06G	20	41	39	47	18	22	1	3/4
PB 250	NABMF 08-10G	20	55	39	57	18	26.5	1	1 1/4
	NABMF 08-12G	20	60	49	59	18	28.5	1	1 1/2
	NABMF 10-08G	25	50	49	52	20	24.5	1 1/4	1
PB 250	NABMF 10-12G	25	60	49	60	20	28.5	1 1/4	1 1/2
	NABMF 12-10G	32	55	55	58	22	26.5	1 1/2	1 1/4
PB 250	NABMF 16-12G	40	70	68	62	24	28.5	2	1 1/2

All dimensions are in millimeters.

Male Female Adaptor
(BSP Parallel) with *ED-Ring
NHB-GE

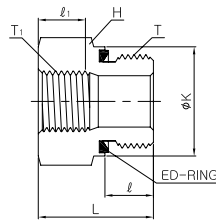

* DIN 3852 Form "E" stud end
* ED-ring of NBR standard, of FPM on request

PB	Part No.	H	K	L	l	l ₁	Male stud T G(PF)	Female stud T ₁ G(PF)
PB 630	NHB 03GE-01G	22	22	22.5	12	8	3/8	1/8
PB 630	NHB 04GE-01G	27	26	24	14	8	1/2	1/8
PB 400	NHB 04GE-02G	27	26	24	14	12	1/2	1/4
PB 400	NHB 06GE-02G	32	32	26	16	12	3/4	1/4
	NHB 06GE-03G	32	32	26	16	12	3/4	3/8
PB 400	NHB 08GE-02G	41	39	29	18	12	1	1/4
	NHB 08GE-03G	41	39	29	18	12	1	3/8
	NHB 08GE-04G	41	39	29	18	14	1	1/2
PB 250	NHB 10GE-04G	50	49	32	20	14	1 1/4	1/2
	NHB 10GE-06G	50	49	32	20	16	1 1/4	3/4
PB 250	NHB 12GE-04G	55	55	36	22	14	1 1/2	1/2
	NHB 12GE-06G	55	55	36	22	16	1 1/2	3/4
	NHB 12GE-08G	55	55	36	22	18	1 1/2	1

All dimensions are in millimeters.

Male Female Adaptor
(BSP Parallel) with *ED-Ring
NABMF-GE

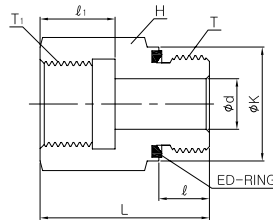

* DIN 3852 Form "E" stud end
* ED-ring of NBR standard, of FPM on request

PB	Part No.	d	H	K	L	l	l ₁	Male stud T G(PF)	Female stud T ₁ G(PF)
PB 630	NABMF 01GE-02G	4	19	14	31	8	17	1/8	1/4
	NABMF 01GE-03G	4	24	14	32	8	17	1/8	3/8
PB6 30	NABMF 02GE-01G	5	19	18	28	12	12	1/4	1/8
	NABMF 02GE-03G	5	24	18	36	12	17	1/4	3/8
	NABMF 02GE-04G	5	30	18	40	12	20	1/4	1/2
PB 400	NABMF 02GE-06G	5	36	18	43	12	22	1/4	3/4
PB 630	NABMF 03GE-02G	8	22	22	36	12	17	3/8	1/4
	NABMF 03GE-04G	8	30	22	41	12	20	3/8	1/2
PB 250	NABMF 03GE-06G	8	36	22	44	12	22	3/8	3/4
PB 400	NABMF 04GE-03G	12	27	26	36	14	17	1/2	3/8
	NABMF 04GE-06G	12	36	26	46	14	22	1/2	3/4
	NABMF 04GE-08G	12	41	26	49	14	24.5	1/2	1
PB 250	NABMF 04GE-10G	10	55	26	53	14	26.5	1/2	1 1/4
PB 400	NABMF 06GE-04G	16	32	32	41	16	20	3/4	1/2
	NABMF 06GE-08G	16	41	32	51	16	24.5	3/4	1
	NABMF 06GE-10G	16	55	32	55	16	26.5	3/4	1 1/4
PB 250	NABMF 06GE-12G	16	60	32	57	16	28.5	3/4	1 1/2
PB 400	NABMF 08GE-06G	20	41	39	47	18	22	1	3/4
PB 250	NABMF 08GE-10G	20	55	39	57	18	26.5	1	1 1/4
	NABMF 08GE-12G	20	60	49	59	18	28.5	1	1 1/2
PB 250	NABMF 10GE-08G	25	50	49	52	20	24.5	1 1/4	1
	NABMF 10GE-12G	25	60	49	60	20	28.5	1 1/4	1 1/2
PB 250	NABMF 12GE-10G	32	55	55	58	22	26.5	1 1/2	1 1/4
PB 250	NABMF 16GE-12G	40	70	68	62	24	28.5	2	1 1/2

All dimensions are in millimeters.

DK DIN Bite Type Tube Fitting

Blanking Plugs with *O-Ring for Ports acc.to ISO 6149 / DIN3852

NVSTI

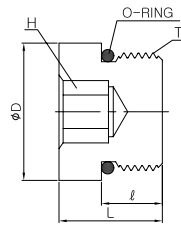

* O-ring of NBR standard, of FPM on request

Series	Part No.(M)	T M(Metric)	D	H	L	ℓ
PB 630	NVSTI-10M10	M 10 x 1	13	5	14	10
	NVSTI-12M15	M 12 x 1.5	17	6	16.5	11.5
	NVSTI-14M15	M 14 x 1.5	19	6	16.5	11.5
	NVSTI-16M15	M 16 x 1.5	21	6	18	13
	NVSTI-18M15	M 18 x 1.5	23	8	19.5	14.5
PB 400	NVSTI-22M15	M 22 x 1.5	27	10	20.5	15.5
	NVSTI-26M15	M 26 x 1.5	31	12	21	16
	NVSTI-27M20	M 27 x 2	32	12	24	19
	NVSTI-33M20	M 33 x 2	38	17	25.5	19
	NVSTI-42M20	M 42 x 2	48	22	26	19.5

All dimensions are in millimeters.

Blanking Plugs with *ED-Ring for Ports

NVSTI-GE / ME

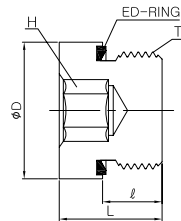

* ED-ring of NBR standard, of FPM on request

Series	Part No.(M)	Part No.(G)	T M(Metric)	T G(PF)	D	H	L	ℓ
PB 400	NVSTI-10M10E	NVSTI-01GE	M 10 x 1	1/8	14	5	12	8
	NVSTI-12M15E	-	M 12 x 1.5	-	17	6	17	12
	NVSTI-14M15E	NVSTI-02GE	M 14 x 1.5	1/4	19	6	17	12
	NVSTI-16M15E	NVSTI-03GE	M 16 x 1.5	3/8	22	8	17	12
	NVSTI-18M15E	-	M 18 x 1.5	-	23.9	8	17	12
	NVSTI-20M15E	-	M 20 x 1.5	-	25.9	10	19	14
	NVSTI-22M15E	NVSTI-04GE	M 22 x 1.5	1/2	27	10	19	14
	NVSTI-26M15E	-	M 26 x 1.5	-	31.9	12	21	16
	NVSTI-27M20E	NVSTI-06GE	M 27 x 2	3/4	32	12	21	16
PB 250	NVSTI-33M20E	NVSTI-08GE	M 33 x 2	1	39.9	17	22.5	16
	NVSTI-42M20E	NVSTI-10GE	M 42 x 2	1 1/4	49.9	22	22.5	16
	NVSTI-48M20E	NVSTI-12GE	M 48 x 2	1 1/2	55	24	22.5	16

All dimensions are in millimeters.

Blanking Plug with *O-Ring NP

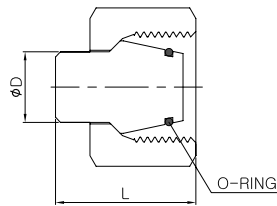

* O-ring of NBR standard, of FPM on request

Series	Part No.	Tube O.D D	L
L light PN315/PN630	NP-06L/S	6	18.5
	NP-08L/S	8	18.5
	NP-10L/S	10	20
	NP-12L/S	12	20.5
	NP-15L	15	20.5
	NP-18L	18	22.5
PN 160	NP-22L	22	25
	NP-28L	28	25.5
	NP-35L	35	30
	NP-42L	42	30
S heavy PN 630	NP-14S	14	22.5
PN 400	NP-16S	16	23.5
	NP-20S	20	28.5
	NP-25S	25	29
	NP-30S	30	30.5
PN 315	NP-38S	38	33

All dimensions are in millimeters.

Tube Cap NCA

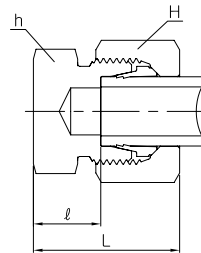

Series	Part No.	Tube O.D	H	h	L	ℓ
L light PN 315	NCA-06L	6	14	12	22	7
	NCA-08L	8	17	14	23	8
	NCA-10L	10	19	17	24	9
	NCA-12L	12	22	19	25	10
	NCA-15L	15	27	24	26	11
	NCA-18L	18	32	27	28	11.5
PN 160	NCA-22L	22	36	32	30	13.5
	NCA-28L	28	41	41	31	14.5
	NCA-35L	35	50	46	36	14.5
	NCA-42L	42	60	55	39	16
S heavy PN 630	NCA-06S	6	17	14	26	11
	NCA-08S	8	19	17	28	13
	NCA-10S	10	22	19	29	12.5
	NCA-12S	12	24	22	31	14.5
	NCA-14S	14	27	24	34	16
PN 400	NCA-16S	16	30	27	34	15.5
	NCA-20S	20	36	32	39	17.5
	NCA-25S	25	46	41	44	20
	NCA-30S	30	50	46	47	20.5
PN 315	NCA-38S	38	60	55	54	23

All dimensions given approx. figure with tighten nut. All dimensions are in millimeters.

DK DIN Bite Type Tube Fitting

Tube Insurt

NIL

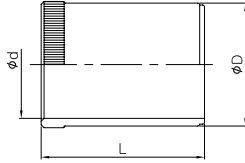

Part No.	Tube O.D.	Tube I.D.	d	D	L
NIL 6-1	6	4	2.6	3.8	15.5
NIL 6-0.75	6	4.5	3.1	4.3	12.5
NIL 6-0.5	6	5	3.6	4.8	15.5
NIL 8-1	8	6	4.6	5.8	15.5
NIL 10-1.5	10	7	5.6	6.8	17
NIL 10-1	10	8	6.6	7.8	16.5
NIL 12-1.5	12	9	7.6	8.8	16.5
NIL 12-1	12	10	8.6	9.8	16.5
NIL 15-1.5	15	12	10.2	11.8	17
NIL 15-1	15	13	11.2	12.8	17
NIL 16-1	16	14	12.2	13.8	17
NIL 18-1.5	18	15	13.2	14.8	17.5
NIL 18-1	18	16	14.2	15.8	17.5

Part No.	Tube O.D.	Tube I.D.	d	D	L
NIL 20-1.5	20	17	15.2	16.8	20
NIL 20-1	20	18	16.2	17.8	22
NIL 22-1.5	22	19	17.2	18.8	18
NIL 22-1	22	20	18.2	19.8	18
NIL 25-2	25	21	19.2	20.8	21.5
NIL 25-1.5	25	22	20.2	21.8	23.5
NIL 28-2	28	24	22.2	23.8	18
NIL 28-1.5	28	25	23.2	24.8	10
NIL 30-2	30	26	24.2	25.8	23.5
NIL 35-2	35	31	28.8	30.8	22.5
NIL 38-3	38	32	29.8	31.8	26.5
NIL 38-2.5	38	33	30.8	32.8	26.5
NIL 42-2	42	38	35.8	37.8	23.5

All dimensions are in millimeters.

Bulkhead Lock Nut

NBUN

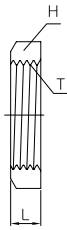

Series	Part No.	Tube O.D.		H	L	T
		Light	Heavy			
L	NBUN 06L	6	-	17	6	M 12 x 1.5
L/S	NBUN 08L-06S	8	6	19	6	M 14 x 1.5
L/S	NBUN 10L-08S	10	8	22	6	M 16 x 1.5
L/S	NBUN 12L-10S	12	1	24	6	M 18 x 1.5
S	NBUN 12S	-	12	27	6	M 20 x 1.5
L/S	NBUN 15L-14S	15	14	30	7	M 22 x 1.5
S	NBUN 16S	-	16	32	7	M 24 x 1.5
L	NBUN 18L	18	-	36	8	M 26 x 1.5
L/S	NBUN 22L-25S	22	20	41	8	M 30 x 2
L/S	NBUN 28L-25S	28	25	46	9	M 36 x 2
S	NBUN 30S	-	30	50	9	M 42 x 2
L	NBUN 35S	35	-	55	9	M 45 x 2
L/S	NBUN 42L-38S	42	38	65	10	M 52 x 2

All dimensions are in millimeters.

Sealing Ring for NWH/NTH and NSWVE

NKA



Part No.	External Thread
NKA-01G	PF 1/8
NKA-02G	PF 1/4
NKA-03G	PF 3/8
NKA-04G	PF 1/2
NKA-06G	PF 3/4
NKA-08G	PF 1
NKA-10G42M20	PF 1-1/4/M42 x 2
NKA-12G48M20	PF 1-1/2/M48 x 2
NKA-M10	M 10 x 1
NKA-M12	M 12 x 1.5
NKA-M14	M 14 x 1.5
NKA-M16	M 16 x 1.5
NKA-M18	M 18 x 1.5
NKA-M20	M 20 x 1.5
NKA-M22	M 22 x 1.5
NKA-M22X4.5	M 22 x 1.5
NKA-M26	M 26 x 1.5
NKA-M26X3.5	M 26 x 1.5
NKA-M27	M 27 x 2
NKA-M33	M 33 x 2

Sealing Ring for NSVW/NSVT

NKAZ

Part No.	External Thread
NKAZ-01G	PF 1/8
NKAZ-02G	PF 1/4
NKAZ-03G	PF 3/8
NKAZ-04G	PF 1/2
NKAZ-06G	PF 3/4
NKAZ-08G	PF 1
NKAZ-10G42M20	PF 1-1/4/M42 x 2
NKAZ-12G48M20	PF 1-1/2/M48 x 2
NKAZ-10M10	M 10 x 1
NKAZ-12M15	M 12 x 1.5
NKAZ-14M15	M 14 x 1.5
NKAZ-16M15	M 16 x 1.5
NKAZ-18M15	M 18 x 1.5
NKAZ-20M15	M 20 x 1.5
NKAZ-22M15	M 22 x 1.5
NKAZ-22M15X4.5	M 22 x 1.5
NKAZ-26M15	M 26 x 1.5
NKAZ-26M15X3.5	M 26 x 1.5
NKAZ-27M20	M 27 x 2
NKAZ-33M20	M 33 x 2

Sealing Ring for NGC

NKI

Part No.	Internal Thread
NKI-02G	PF 1/4
NKI-04G	PF 1/2

All dimensions are in millimeters.

ED-Ring
NED



O-Ring
NOR

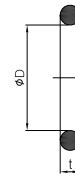

Part No.	For Male Thread	
	Metric	G(PF)
NED-NM8	M 8 x 1	-
NED-N01G	M 10 x 1	1/8
NED-NM12	M 12 x 1.5	-
NED-N02G	M 14 x 1.5	1/4
NED-NM16	M 16 x 1.5	-
NED-N03G	-	3/8
NED-NM18	M 18 x 1.5	-
NED-NM20	M 20 x 1.5	-
NED-N04G	-	1/2
NED-NM22	M 22 x 1.5	-
NED-N06G	M 26 x 1.5	3/4
	M 27 x 1.5	
NED-N08G	M 33 x 2	1
NED-N10G	M 42 x 2	1 1/4
NED-N12G	M 48 x 2	1 1/2

Part No.	D	T
NOR-NS06	4	1.5
NOR-NS08	6	1.5
NOR-NS10	7.5	1.5
NOR-NS12	9	1.5
NOR-NS14	10	2
NOR-NS16	12	2
NOR-NS18	15	2
NOR-NS20	16.3	2.4
NOR-NS22	20	2
NOR-NS25	20.3	2.4
NOR-NS30	25.3	2.4
NOR-NS28	26	2
NOR-NS35	32	2.5
NOR-NS38	33.3	2.4
NOR-NS42	38	2.5

All dimensions are in millimeters. ED-ring and O-ring of NBR standard, of FPM on request

Tube end Dimension

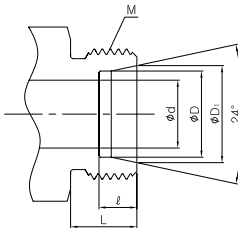

Nut
NN

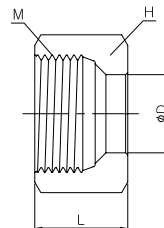

Cutting Ring
NS

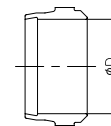

Series	Part No. Nut	Part No. Cutting Ring	Tube O.D	DN Size	D	D ₁	d	H	L	M	ℓ	ℓ_1
LL very light	NN-04LL	NS-04LL	4	3	4	5	3	10	11.5	M 8 x 1.0	4	8
	NN-06LL	NS-06LL	6	4	6	7.5	4.5	12	12	M 10 x 1.0	5.5	8
	NN-08LL	NS-08LL	8	6	8	9.5	6	14	12.5	M 12 x 1.0	5.5	9
	NN-10LL	NS-10LL	10	8	10	11.5	8	17	12.5	M 14 x 1.0	6	9
	NN-12LL	NS-12LL	12	10	12	13.5	10	19	13	M 16 x 1.0	6	9
L light	NN-06L	NS-06	6	4	6	8.1	4	14	15	M 12 x 1.5	7	10
	NN-08L	NS-08	8	6	8	10.1	6	17	15	M 14 x 1.5	7	10
	NN-10L	NS-10	10	8	10	12.3	8	19	16	M 16 x 1.5	7	11
	NN-12L	NS-12	12	10	12	14.3	10	22	16	M 18 x 1.5	7	11
	NN-15L	NS-15	15	12	15	17.3	12	27	17.5	M 22 x 1.5	7	12
	NN-18L	NS-18	18	16	18	20.3	15	32	18	M 26 x 1.5	7.5	12
	NN-22L	NS-22	22	20	22	24.3	19	36	20.5	M 30 x 2	7.5	14
	NN-28L	NS-28	28	25	28	30.3	24	41	21	M 36 x 2	7.5	14
	NN-35L	NS-35	35	32	35	38	30	50	24	M 45 x 2	10.5	16
	NN-42L	NS-42	42	40	42	45	36	60	24	M 52 x 2	11	16
S heavy	NN-06S	NS-06	6	3	6	8.1	4	17	16.5	M 14 x 1.5	7	12
	NN-08S	NS-08	8	4	8	10.1	5	19	16.5	M 16 x 1.5	7	12
	NN-10S	NS-10	10	6	10	12.3	7	22	17.5	M 18 x 1.5	7.5	12
	NN-12S	NS-12	12	8	12	14.3	8	24	18	M 20 x 1.5	7.5	12
	NN-14S	NS-14	14	10	14	16.3	10	27	20.5	M 22 x 1.5	8	14
	NN-16S	NS-16	16	12	16	18.3	12	30	21	M 24 x 1.5	8.5	14
	NN-20S	NS-20	20	16	20	22.9	16	36	24	M 30 x 2	10.5	16
	NN-25S	NS-25	25	20	25	27.9	20	46	27	M 36 x 2	12	18
	NN-30S	NS-30	30	25	30	33	25	50	29.5	M 42 x 2	13.5	20
	NN-38S	NS-38	38	32	38	41	32	60	32.5	M 52 x 2	16	22

All dimensions are in millimeters.



Safe Component Selection

The Selection of component for any applications or system design must be considered to ensure safe performance. Component function, material compatibility, component ratings, proper installation, operation and maintenance remain the sole responsibility of the system designer and the user. DK Tech accepts no liability for any improper selection, installation, operation or maintenance.